

杭州佳枫汽车配件有限公司

Hangzhou Bestmaple Auto Parts Co., Ltd.



## CONTENTS / 目录

Professional catalog for auto HVAC blower motor and cooling fan series.

### Brand Upgrade

- BESTMAPLE branding applied
- Company information updated
- Product codes changed to BS
- Clean business-style layout
- Global supply and export service

### Contact

Phone / WhatsApp: (+86) 13600630070

Website: www.best-maple.com

|                               |         |         |
|-------------------------------|---------|---------|
| European Car Series           | 欧洲车系列   | 01 - 14 |
| American Car Series           | 美国车系列   | 15 - 22 |
| Japan Car Series              | 日本车系列   | 23 - 40 |
| Korea Car Series              | 韩国车系列   | 41 - 42 |
| Southeast Asia Car Series     | 东南亚车系列  | 43 - 44 |
| Agricultural Vehicles Series  | 农用车系列   | 45 - 46 |
| Excavator Series              | 挖掘机系列   | 47 - 54 |
| Truck Series                  | 重卡系列    | 55 - 64 |
| Universal Fan Series          | 通用扇系列   | 65 - 72 |
| Special Electronic Fan Series | 专业电子扇系列 | 73 - 77 |
| Only Motor Series             | 单电机系列   | 78 - 82 |



| BS-66139   |   | BS-66139F                               |   |
|--|---|---|---|
|  | Diamater:<br>149.5X75MM<br>Direction:CCW                              |   | Diamater:<br>149.5X75MM<br>Direction:CCW(RHD) |
| 7L0820021L<br>7L0820021M<br>7L0820021Q<br>2H1820021<br>17771BA11<br>2H1820021A | AUDI Q7(2006-/<br>PORSCHE CAYENNE(2002-/<br>VW AMAROK,TOUAREG(2002-/) | 7L0820021S<br>7L0820021A<br>95557234300 | AUDI Q7(2006-/)                               |
| BS-66145   |   | BS-66145D                               |   |
|  | Diamater:<br>133X63MM<br>Direction:CCW                                |   | Diamater:<br>133X63MM<br>Direction:CCW        |
| 8K1820021B/C   | AUDI A4,A5,Q5(2007-2015)  | 8T1820021                               | AUDI A4 A5 S4 S5 RS5<br>Q5 SQ5 (2013-2017)    |
| BS-66146   |   | BS-66147                                |   |
|  | Diamater:<br>149X74MM<br>Direction:CCW                                |   | Diamater:<br>150X74.5MM<br>Direction:CCW      |
| 4F082020A<br>4F0820020<br>4F0815020  | AUDI A6L(2005-2010)<br>AUDI R8L(2009-2010)                            | 4B2820021C                              | AUDI A6(1997-2005)                            |
| BS-66149   |   | BS-66155BL                              |   |
|  | Diamater:<br>150X75MM<br>Direction:CCW                                |   | Diamater:<br>MM<br>Direction:CCW              |
| 7P0820021B<br>7P0820021<br>0130115559<br>7P0820021F                            | VW TOUAREG<br>AUDI Q7 NEW   | 4H1820021B/A                            | AUDI A6 A7 A8                                 |

BLOWER MOTOR



| BS-66145F                |  | BS-67211F  |  |
|--------------------------|--|--|--|
|                          | Diamater:<br>Direction:CCW                                       |  | Diamater:<br>Direction:CCW                                       |
| 8K2820021C               | AUDI A5 (8T3) A4 (8K2, B8) RHD                                   | 18305708   | BENZ SPRING 02-06 LHD  |
| BS-67101                 |  | BS-67101FR   |  |
|                          | Diamater:<br>133X61.5MM<br>Direction:CCW                         |  | Diamater:<br>133X61.5MM<br>Direction:CCW(RHD)                    |
| 2128200708               | BENZ C-CLASS,<br>C-CLASS T-MODELE-CLASS<br>COUPE E-CLASS(2007-/) | 2048200108<br>2048200908<br>A2048200108<br>A2048200908<br>8EW351040291 | Benz W204 S204, E W212 S212                                      |
| BS-67101S                |  | BS-67101FS   |  |
|                          | Diamater:<br>133X61.5MM<br>Direction:CCW                         |  | Diamater:<br>133X61.5MM<br>Direction:CCW                         |
| 2048200208               | BENZ C-CLASS,C-CLASS<br>T-MODELE-CLASS COUPE<br>E-CLASS(2007-/)  | 2048200008   | BENZ C-CLASS,<br>C-CLASS T-MODELE-CLASS<br>COUPE,E-CLASS(2007-/) |
| BS-67103A                |  | BS-67104   |  |
|                          | Diamater:<br>Direction:CCW                                       |  | Diamater:119 X 58MM<br>Direction:CCW(RHD)                        |
| 9130451222<br>9130451143 | Mercedes Caminhões 12V   | A4518301600  | Benz Smart Fortwo 451 2008-2016                                  |

BLOWER MOTOR



| BS-67105AF                                |  | BS-67106F                           |  |
|---|--|-------------------------------------|--|
|   | Diamater:<br>Direction:CCW                           |                                     | Diamater:<br>119 X 58MM<br>Direction:CCW     |
| F006.B10.415-741<br>F006B10415741         | Ford Cargo 2007><br>Volkswagen Worker 17180 12 Volts | AA0008356107<br>0008356007          | Benz Sprinter 415 / 515<br>31 Ano 2013>      |
| BS-67107A                                 |  | BS-67203F                           |  |
|   | Diamater:<br>Direction:CCW                           |                                     | Diamater:<br>150 X69MM<br>Direction:CCW(RHD) |
| RC.530.841                                | Volkswagen Gol 00><br>Geração III/ 12 Volts          | 982485PV<br>1698200642              | Benz B-Klasse B180 CDI W245<br>W245, W169    |
| BS-67206F                                 |  | BS-67208                            |  |
|   | Diamater:<br>163 X 65MM<br>Direction:CCW             |                                     | Diamater:<br>Direction:CCW(LHD)              |
| 2118300908<br>8EW009159-601<br>2118300408 | Benz W211 S211 C219 E320 E350                        | 2208203142<br>2108203442            | Benz W220                                    |
| BS-67208F                                 |  | BS-67209FDZ                         |  |
|   | Diamater:<br>Direction:CCW(RHD)                      |                                     | Diamater:<br>150 X69MM<br>Direction:CCW      |
| 2208203542                                | Benz W220  | OEM 1698201342<br>EAN 4059191751303 | MERCEDES-BENZ                                |









BLOWER MOTOR





| BS-67210F                |  | BS-67211   |                                  |            |                            |
|--------------------------|--|--|----------------------------------|------------|----------------------------|
|                          | Diamater:<br>Direction:CCW(RHD)  |  | Diamater:<br>Direction:CCW(RHD)  |            |                            |
| V30031255<br>2028209342  | Benz W202 รุ่นใหม่   | 18305808<br>F651674J<br>05991165                                   | Benz Vito 1996-2004 (W638) Front |            |                            |
| BS-66217                 |  | BS-66217S  |                                  | BS-67213F  |                            |
|                          | Diamater:<br>148X77MM<br>Direction:CCW                                       |  | Diamater:<br>Direction:CCW       |            | Diamater:<br>Direction:CCW |
| 13263279<br>13369460     | BUICK LACROSSE(2010-2011)<br>BUICK ALLURE 2010<br>CHEVROLET CRUZE(2011-2015) | 15-81732<br>15-81755<br>20782694<br>22956040<br>TYC76904<br>PM9375 |                                  | RC.530.218 | BENZ SC SOPLADOR VS30      |
| BS-77073                 |  |  | BS-77083                         |            |                            |
|                          | Diamater:<br>Direction:  |  | Diamater:<br>Direction:          |            |                            |
| 2218200514<br>2218202714 | Benz C216 W221 (05-2013)   | 2228202214   | BENZ W222 X222 C217              |            |                            |
| BS-66159FBL              |  |  |                                  |            |                            |
|                          | Diamater:<br>Direction:CCW   |  |                                  |            |                            |
| 1648350007               | BENZ W164 251  |  |                                  |            |                            |

BLOWER MOTOR



| BS-67201  |  | BS-67201F   |   |
|---|--|---|---|
|    | Diameter:<br>147.5X70.6MM<br>Direction: CW           |   | Diameter:<br>147.5X70.6MM<br>Direction: CCW                                   |
| 64119242607   | ALPINAB7(2009-<br>ALPINAB6(2011-<br>BMW 7,5,6(2008-) | 64119242608<br>64119200935<br>64119194590<br>8EW351043261                           | ALPINAB7(2009-<br>ALPINAB6(2011-<br>BMW 7,5,6(2008-)                          |
| BS-67202DZ  |  | BS-67202SDZ   |   |
|    | Diameter:<br>150 X69MM<br>Direction: CCW<br>LHD      |    | Diameter:<br>150 X69MM<br>Direction: CW                                       |
| 64119227670<br>64116933663<br>64119144200   | BMW E87 E90 Z4 1 3 SERIES                            | 64116933664<br>64119144201<br>64119227671<br>985467WV                               | BMW E81 E82 E84 E87<br>E89 E90 E91 12005                                      |
| BS-67204FDZ   |  | BS-67205  |   |
|  | Diameter:<br>Direction: CCW(LHD)                     |  | Diameter:<br>Direction: CW  |
| 64116971108<br>9229000  | BMW X5 X6 E72 E71<br>E70 (06-14) LHD                 | 67326935371   | MINI cooper   |
| BS-67207DZ  |  | BS-66203  |   |
|  | Diameter:<br>155 X70MM<br>Direction: CW              |  | Diameter:<br>141X63.5MM<br>141X64.5MM<br>Direction: CW                        |
| 64119350395   | BMW F20 328D 328I<br>330E 330I 335I 12-17            | 64118372797<br>641134537297<br>2311001<br>9159201<br>64116900685                    | 23 DD BMW BLOWER MOTOR<br>BEHR 39017 1999 E46 323I &<br>OTHER LISTED VEHICLES |



| BS-77071  |  | BS-77072  |   |
|---|--|---|---|
|  | Diameter:<br>144.5X47.5MM<br>Direction: CW |  | Diameter:<br>147X65MM<br>Direction:       |
| 64116933910<br>8EW351040-651  | BMW E60,5系                                 | 641183855589<br>641183724939<br>64118385558   | BMW E39(95-03 老5系<br>525 530 540 X5 00-06 |

| BS-66136DZ  |   | BS-66136FDZ  |   |
|---|---|--|---|
|    | Diameter:<br>148.5X70MM<br>Direction: CW  |    | Diameter:<br>148.5X70MM<br>Direction: CCW(RHD)  |
| 1K1 820 015<br>1K1 820 015 A/C<br>3C1820015AA                                       | AUDI A3,Q3,TT(2006-/<br>SEAT ALHAMBRA,LEON,<br>TOLEDO(2004-/<br>SKODA OCTAVIA,SUPERB,<br>YETI(2004-/<br>VW CADDY,EOS,JETTA,GOLF,<br>PASSAT,TIGUAN,TORAN(1994-/<br>) | 1K2820015<br>1K2820015A  | AUDI A3,Q3,TT(2006-/<br>SEAT ALHAMBRA,LEON,<br>TOLEDO(2004-/<br>SKODA OCTAVIA,SUPERB,<br>YETI(2004-/<br>VW CADDY,EOS,JETTA,GOLF,<br>PASSAT,TIGUAN,TORAN(1994-/<br>) |
| BS-66137  |   | BS-66139R  |   |
|    | Diameter:<br>148.5X70MM<br>Direction: CW(LHD)   |    | Diameter:<br>149.5X75MM<br>Direction: CW(RHD)   |
| 23155089  | AUDI A3,Q3,TT(2006-/<br>SEAT ALHAMBRA,LEON,<br>TOLEDO(2004-/<br>SKODA OCTAVIA,SUPERB,<br>YETI(2004-/<br>VW CADDY,EOS,JETTA,GOLF,<br>PASSAT,TIGUAN,TORAN(1994-/<br>) | 7H2819021B<br>7H2819021D<br>7E1820021  | VW MULTIVAN MK5 T5 (2003-2015)<br>VW TRANSPORTER MK5 T5 (2003-2015)<br>VW MK5 T5 (2003-2015)<br>VW MK6 T6 (2015-2018)   |
| BS-66141  |   | BS-66142   |   |
|  | Diameter:<br>145X70.5MM<br>Direction: CW(RHD)   |  | Diameter:<br>148.5X70MM<br>Direction: CCW   |
| 1J2819021C<br>1J2819021<br>1J2819021A/B   | AUDI A3,TT(1996-2006)<br>VW POLO,GOLF IV,LUPO,NEW<br>BEETLE,JETTA IV,BORA(1995-2010)<br>SEAT OCTAVIA,AROSA,TOLEDO,<br>CORDOBA,LEON,IBIZAIII(1996-2010)              | 8D1820021<br>8D1820021B  | AUDI A4(1995-2001)<br>VW PASSAT(1996-2005)<br>SKODA SUPERB(2002-2008)   |
| BS-66143  |   | BS-66144   |   |
|  | Diameter:<br>148.5X70MM<br>Direction: CCW   |  | Diameter:<br>174X70MM<br>Direction: CCW   |
| 8D1820021A<br>8D1820021C  | AUDI A4(1995-2001)<br>VW PASSAT(1996-2005)<br>SKODA SUPERB(2002-2008)   | 6Q1820015  | SEAT CORDOBA,IBIZA(2002-/<br>SKODA FABIA ROOMSTER,PRAKTIK<br>(1999-/<br>VW POLO,DERBY SALOON(2001-/<br>VENTO SALOON(2009-/<br>)                                     |

BLOWER MOTOR



| BS-66148DZ  |  | BS-66152F   |   |
|---|--|---|---|
|    | Diameter:<br>153X60MM<br>Direction: CCW<br>带电阻                                   |    | Diameter:<br><br>Direction: CCW           |
| 5Q0819021A<br>5Q1819021B/A/E<br>5Q1819021H<br>5QD819021A                              | VW ARTEON(2017-/<br>VW PASSAT(2015-/<br>VW TIGUAN(2015-/<br>VW GOLF (2017-/<br>) | 700886<br>996014W<br>5U0820021B   | VW - Volkswagen Geração Gol 2009          |
| BS-66154F   |  | BS-66157F   |   |
|    | Diameter:<br><br>Direction: CCW  |    | Diameter:<br><br>Direction: CCW           |
| 95557206100<br>7H0819021A<br>7H0819021<br>95557206101<br>7E0819021A                   | VW T5 T6   | OEM-AG 4BW<br>2Q1819021A  | 德系  |
| BS-66158F   |  | BS-66160B   |   |
|  | Diameter:<br><br>Direction: CCW  |  | Diameter:<br><br>Direction: CW            |
| 2Q1820021   | 德系   | 23B819015<br>HD822001   | VW DELIVERY 9-170<br>11-180/13-180<br>24V |
| BS-66165  |  |   |   |
|  | Diameter:<br><br>Direction: CW   |   |   |
| F006B10310741   | Volkswagen Fox / Gol G5 /<br>Saveiro G5 / Voyage 12 Volts                        |   |   |

BLOWER MOTOR



| BS-66701              |  | BS-66702   |   |
|-----------------------|--|--|---|
|                       | Diamater:<br>147.5x71MM<br>Direction: CW                           |  | Diamater:<br><br>Direction: CW                    |
| 46722992              | FIAT DUCATO 06-08  | 46723715<br>46723714<br>46722956<br>141730600<br>71735484<br>069412504010                    | FIAT PUNTO (2000-/)                               |
| BS-66702F             |  | BS-66708   |   |
|                       | Diamater:<br><br>Direction: CCW                                    |  | Diamater:<br><br>Direction: CW                    |
| 77362402              | FIAT Idea 350  | 7088614<br>7088222<br>7082288<br>Denso<br>5A373030AM   | Fiat Idea/Palio/Siena/Strada<br>Weekend 2004>2011 |
| BS-66709              |  | BS-66712F  |   |
|                       | Diamater:<br><br>Direction: CCW                                    |  | Diamater:<br><br>Direction: CCW                   |
| 5T5930100             | Fiat Toro 2017<br>Motor 2.4 16 Valvulas Jeep<br>Renegade / Compass | 1318888080<br>1307829080<br>K410003R   | Fiat Ducato 01 > 05                               |
| BS-66713              |  | BS-66717   |   |
|                       | Diamater:<br><br>Direction: CW                                     |  | Diamater:<br>120 X 84MM<br>Direction: CW          |
| 7077161<br>9130451074 | Fiat Uno 2005  | DS676084<br>51836362<br>52460703<br>51836347<br>77366203<br>77366253<br>77366916<br>77368879 | Fiat Uno Palio 2010-20<br>New Holland T6          |

BLOWER MOTOR



| BS-66719F                      |  | BS-66734                 |   |
|--------------------------------|--|--------------------------|---|
|                                | Diamater:<br><br>Direction: CCW          |                          | Diamater:<br><br>Direction: CW            |
| 7078699                        | Fiat Palio 1996 - 2005                   | 77364058                 | FIAT DUCATO III L2H2                      |
| BS-66745                       |  | BS-66747                 |   |
|                                | Diamater:<br><br>Direction: CW           |                          | Diamater:<br><br>Direction: CW            |
| 46722702<br>6441S4<br>71734232 | FIAT DUCATO 2.8D 02-<br>INTERIOR BLOWERS | 46722574                 | FIAT SEICENTO 1.1 98-<br>INTERIOR BLOWERS |
| BS-67403                       |  | BS-66815                 |   |
|                                | Diamater:<br><br>Direction: CW           |                          | Diamater:<br><br>Direction: CW            |
| 6441S6<br>6441.S6              | Citroen C4 Pallas Todos<br>Hatch 1.6     | 1609994480<br>1608182080 | Peugeot 208<br>3008 Citroen C4 2013       |
| BS-66161                       |  | BS-66162F                |   |
|                                | Diamater:<br><br>Direction: CW           |                          | Diamater:<br><br>Direction: CCW(RHD)      |
|                                | Volvo 740,940                            |                          | Volvo 760.960                             |

BLOWER MOTOR



|   |                                  |  |  |
|---|----------------------------------|--|--|
| BS-66163                                    |                                  | BS-66217S  |  |
|   | Diamater:<br>Direction:CCW(RHD)  |  | Diamater:<br>148X77MM<br>Direction: CW     |
| 6820812<br>6849031<br>6849562               | Volvo 850                        | 5242673301   | Saab NG 9-5 95 (萨博 NG 9-5 95)<br>2010-2012 |
| BS-77104                                    |                                  | BS-66711F  |  |
|   | Diamater:<br>Direction:          |  | Diamater:<br>Direction:CCW                 |
| 272104377R                                  | Renault Fluence                  | 1738300100<br>4158350800<br>7701068992   | Renault Master 2013                        |
| BS-66718                                    |                                  | BS-66718F  |  |
|   | Diamater:<br>Direction: CW       |  | Diamater:<br>Direction: CCW                |
| 7701056965<br>7701055135<br>8EW 351 149-664 | RENAULT                          | 272269U01A<br>7701062226<br>7701062225<br>272269U01A<br>8EW351149684<br>698755<br>6001547691 | RENAULT                                    |
| BS-66720F                                   |                                  | BS-66725F  |  |
|   | Diamater:<br>Direction:CCW       |  | Diamater:<br>Direction:CCW                 |
| 6001552011                                  | Renault Logan / Sandero / Duster | A1J50100   | RENAULT KWIND 2015-2022<br>12Volts         |

BLOWER MOTOR







|  |  |  |   |
|--|--|--|---|
| BS-66731   |  | BS-66732   |   |
|  | CH-B4658 (DY 8847)                                   |  | Diamater:<br>Direction: CW  |
| 530.219  | CITROEN C3 II 12/08 -<br>RENAULT GRAND SCÉNIC II 05- | 530.216  |   |
| BS-67404   |  | BS-66816F  |   |
|  | Diamater:<br>Direction: CW                           |  | Diamater:<br>Direction: CCW   |
| 0130063102<br>7701046084<br>7701038210<br>52479327<br>0130111169 | Renault Twingo 96-16                                 | 272108177R<br>272100736R<br>272100975R<br>272107379R | Ventilador da Caixa<br>Evaporadora Renault Sandero<br>Logan Ar Analogico 2013   |
| BS-66735   |  | BS-66735F  |   |
|  | Diamater:<br>Direction: CW                           |  | Diamater:<br>Direction: CCW   |
| 2720500QAL<br>4415548<br>7701057556<br>93181460                  | RENAULT MASTER 2.5D 98-<br>INTERIOR BLOWERS          | 7701057555<br>8EW009158211                           | renault master II<br>opel Movano LHD 12V<br>Renault Master 2009 2013<br>4415547 |
| BS-66741   |  | BS-66741F  |   |
|  | Diamater:<br>Direction: CW                           |  | Diamater:<br>Direction: CW  |
| 7701046058   | RENAULT MEGANE 1.6 96-<br>INTERIOR BLOWERS           | 2761400QAC<br>4409448<br>7701050310<br>91158687      | RENAULT TRAFIC 2.0D 01-<br>INTERIOR BLOWERS                                     |

BLOWER MOTOR



... RNO



| BS-66742  |   | BS-66743F   |   |
|---|---|---|---|
|  | Diameter:<br>Direction: CW                  |  | Diameter:<br>Direction: CCW                 |
| 2720500QAC<br>7701044126<br>7701048387  | RENAULT SCENIC 1.9D 96-<br>INTERIOR BLOWERS | 7701059205  | RENAULT KANGOO 1.5D 98-<br>INTERIOR BLOWERS |
| BS-66744  |   | BS-66746F   |   |
|  | Diameter:<br>Direction:                     |  | Diameter:<br>Direction: CCW                 |
| 7701040540  | RENAULT                                     | 7701044818<br>7701206105  | RENAULT CLIO 1.2 98-<br>INTERIOR BLOWERS    |

BLOWER MOTOR



... IVECO



| BS-66817  |                            | BS-66820   |   |
|---|----------------------------|--|---|
|  | Diameter:<br>Direction: CW |   | Diameter:<br>Direction: CW  |
| 5M8626100   | Iveco Daily 35S14          | 6441RO   | Peugeot 206 2000 Até 2008<br>Peugeot 207 / Citroën C3<br>Picasso Novo |
| BS-77079  |                            | BS-66740F  |   |
|  |                            |   | Diameter:<br>Direction: CCW   |
| 036558E   | IVECO EUROCARGO 08-15      | 13335075 1611726380<br>1611726480 1845112<br>1845113 1845133<br>55702442 55702443<br>6441AN 6441BC<br>77364529 77364826<br>77364951 77364956<br>77366856 | OPEL CORSA 1.2 07-<br>INTERIOR BLOWERS                                |

BLOWER MOTOR





|                                   |  |                                     |  |
|-----------------------------------|--|-------------------------------------|--|
| BS-66651                          |  | BS-66652                            |  |
|                                   | Diameter:<br>155*69.5MM<br>Direction: CW |                                     | Diameter: 155X89MM<br>Direction: CCW         |
| 1696010<br>3M5H18456AD<br>1362640 | 福特福克斯 FORD FOCUS                         | 7G9T18456AA                         | 福特麦柯斯-致胜 FORD MONDEO                         |
| BS-66653                          |  | BS-66654                            |  |
|                                   | Diameter:<br>155X79MM<br>Direction: CCW  |                                     | Diameter:<br>MM<br>Direction: CW             |
| 4S7H19D859AA<br>3S7H18456AB       | 福特蒙迪欧04-07款<br>FORD MONDEO 04-07         | 9M59-18456-AA                       | 福特福克斯09款 FORD FOCUS 09                       |
| BS-66655                          |  | BS-66656                            |  |
|                                   | Diameter:<br>150X74.5MM<br>Direction: CW |                                     | Diameter:<br>MM<br>Direction: CW             |
| DG80-61B10                        | 福特新嘉年华 FORD FIESTA                       |                                     | 福特 FORD                                      |
| BS-66657                          |  | BS-66658                            |  |
|                                   | Diameter:<br>Direction: CW               |                                     | Diameter:<br>135X100MM<br>Direction: CW(RHD) |
|                                   | 福特 FORD                                  | VP2S6H18456BD<br>1206931<br>1252927 | FORD FIESTA(2002-2010)<br>FUSION(2002-2012)  |

BLOWER MOTOR



|  |   |  |  |
|--|---|--|--|
| BS-66659   |   | BS-66659F  |  |
|  | Diameter:<br>143X74MM<br>Direction: CW  |  | Diameter:<br>Direction: CCW  |
| AV1Z19805C<br>AV11-19846AB<br>1804473<br>GK2918456AA                       | 福特新全顺 Transil-150 (16-19款)<br>福特途睿欧 V362 Ford Ecosport2012<br>Ford Mendeo         | AV11-19846-BB 34167<br>87710 1752046<br>1804473 AV1119846BA<br>2311934 AV1119846BB<br>AV1119846BA<br>1752046 1804473<br>1804473 AV1119846BB<br>1752046 AV1119846BA | Ford B-Max JK [2012-2019]<br>Ford Ecosport -- [2012-2019]<br>Ford Tourneo Courier - [2014-2019]<br>Ford Transit - [2006-2019]            |
| BS-66660   |   | BS-66661F  |  |
|  | Diameter:<br>153X79.5MM<br>Direction: CW  |  | Diameter:<br>148X75MM<br>Direction: CCW  |
| XC3H-19805-AA<br>XC3Z-19805-CA<br>2C3Z19834-AA<br>615-00587<br>IC3H19846BA | FORD F-550 F-450<br>F-350 F-250(1999-2007)  | F00S3B2444   | 福特 锐界 2012款<br>FORD Ranger 2012(NEW)   |
| BS-66661ZFF  |   | BS-66662   |  |
|  | Diameter:<br>148X75MM<br>Direction: CW  |  | Diameter:<br>Direction: CCW  |
| 264457   | Forde Ranger 2013>  | 2T1H18456AA  | FORD C-MAX Galaxy<br>FORD FOCUS(1998-2004)<br>FORD Mondeo(2000-2002)<br>Ford Focus 00-07<br>Jaguar X-Type 01-08<br>Transit Connect 10-13 |
| BS-66663/ BS-66663F  |   | BS-66664/66664F  |  |
|  | Diameter:<br>146X65MM<br>Direction: CW/CCW  |  | Diameter:<br>145X70MM<br>Direction: CW/CCW   |
| FD-B0101A 01221  | FORD Ranger(RHD)<br>MAZDA BT-05(OLD)/<br>FORD Ranger(OLD)<br>MAZDA BT-05(OLD)福特98 | DC-184546-BC   | 福特新全顺 V348 FORD V348   |

BLOWER MOTOR



| BS-66665/BS-66665F   |  | BS-66667  |  |
|--|--|---|--|
|  | Diameter:<br>165X70MM<br>Direction: CW                               |   | Diameter:<br>137X65.3MM<br>Direction: CW         |
| DG9H-19846-AB<br>DG9H-19846-AA<br>DG9Z-19805-B<br>7T4Z19805A | FORD Fusion(2013-2015)<br>lincoln(2013-2014)<br>福特锐界 2015款 蒙迪欧 2013款 | F006B10415<br>F006B10067                                    | Ford Cargo 2007<br>Volkswagen Worker 17180       |
| BS-66668   |  | BS-66669  |  |
|  | Diameter:<br>157X75 MM<br>Direction: CW                              |   | Diameter:<br>146 X83MM<br>Direction: CW          |
| 1L5H-19805-AA  | Forde Ranger 1998>2011   | 530.004   | Ford F1000 95>                                   |
| BS-66670F  |  | BS-66671A   |  |
|  | Diameter:<br>Direction: CCW  |   | Diameter:<br>Direction: CW                       |
| 530.031  | Ford Ka/Fiesta <2009<br>福特嘉年华<2009                                   | 99209285  | Ford Cargo 2007/ 12volts                         |
| BS-66672F  |  | BS-66673F   |  |
|  | Diameter:<br>Direction: CCW  |   | Diameter:<br>Direction: CCW                      |
| 8U2Z-19805-A<br>TYC700015                                    | Ford Escort 2002-1991<br>Mercury Tracer 1999-1997                    | 5L8Z 19805 AA<br>YL8Z 19805 DA<br>EC07-61-14ZB<br>TYC700065 | Ford Escape 2007-2001<br>Mazda Tribute 2006-2001 |

BLOWER MOTOR



| BS-66662F            |  | BS-66210             |   |
|----------------------|--|----------------------|---|
|                      | Diameter:<br>Direction: CCW  |                      | Diameter:<br>164X71MM<br>Direction: CW      |
| 2T1H18456AA          | FORD C-MAX Galaxy<br>FORD FOCUS(1998-2004)<br>FORD Mondeo(2000-2002) | 9030701              | 08款凯越 CHEVROLET<br>BUICK EXCELLE            |
| BS-66211             |  | BS-66212             |   |
|                      | Diameter:<br>146.5 X 70MM<br>Direction: CCW                          |                      | Diameter:<br>134 X 63.5MM<br>Direction: CCW |
| 52442551             | 别克GL8 BUICK GL8  | 13276230<br>1845105  | 别克英朗 BUICK EXCELLE XT/G                     |
| BS-66213             |  | BS-66214             |   |
|                      | Diameter:<br>150X64.5MM<br>Direction: CCW                            |                      | Diameter:<br>139X75MM<br>Direction: CW      |
| 9029862              | 新赛欧(13款凯越)<br>CHEVROLET SAIL   | 96554418             | 别克老凯越 BUICK EXCELLE OLD                     |
| BS-66215             |  | BS-66216             |   |
|                      | Diameter:<br>155 X77MM<br>Direction: CCW                             |                      | Diameter:<br>155X77MM<br>Direction: CCW     |
| 52489329<br>52487088 | 别克君威2插 BUICK REGAL   | 52442551<br>52485612 | 别克君威3插 BUICK REGAL                          |

BLOWER MOTOR

| BS-66217  |  | BS-66218   |  |
|---|--|--|--|
|    | Diameter:<br>148X77MM<br>Direction:CCW               |    | Diameter:<br>157X72.5MM<br>Direction:CCW   |
| 13369460<br>13263279  | 迈瑞宝、科鲁兹、新君威、新君越<br>BUICK LACROSSE<br>CHEVROLET CRUZE | 9072873  | 雪佛兰景程 CHEVROLET EPICA  |
| BS-66219  |  | BS-66220   |  |
|    | Diameter:<br>150X64MM<br>Direction:CCW               |    | Diameter:<br>149X64MM<br>Direction:CCW   |
| 95472959  | 雪佛兰爱唯欧 CHEVROLET AVEO                                | 23155089   | 别克新英朗-15 BUICK EXCELLE NEW   |
| BS-66299  |  | BS-66906   |  |
|  | Diameter:<br>148X60.5MM<br>Direction:CW              |  | Diameter:<br>146X65MM<br>Direction:CW  |
| 92100919  | 别克老赛欧 BUICK SALL                                     | 96539656<br>95978693   | 雪佛兰爱唯欧04-10 PONTIAC G3 09<br>CHEVROLET AVEO 04-10  |
| BS-66906F   |  | BS-66221   |  |
|  | Diameter:<br>146X65MM<br>Direction:CCW               |   | Diameter:<br>153 X 77 MM<br>Direction:CW   |
| 96539656<br>95978693  | 雪佛兰爱唯欧04-10 PONTIAC G3 09<br>CHEVROLET AVEO 04-10    | 52400424   | Chevrolet Suburban 1500 2500,<br>GMC Yukon XL 1500 2500<br>Sierra 1500 2500 3500 2002-2006 |

BLOWER MOTOR

| BS-66222  |   | BS-66223  |  |
|---|---|---|--|
|    | Diameter:<br>156 X 75 MM<br>Direction:CW  |    | Diameter:<br>155 X 75 MM<br>Direction:CW             |
| 89019320<br>89019301<br>25973845  | Cadillac Escalade ESV, EXT 2007-2013<br>Chevy Silverado 2003-2006<br>Suburban 2003-2011<br>Avalanche 2003-2005<br>GMC Sierra 2003-2007<br>GMC Yukon 2003-2011 | 89019178  | Isuzu i-280 i-290 i-350 i-370                        |
| BS-66624F   |   | BS-66625  |  |
|    | Diameter:<br>153 X 76 MM<br>Direction:CCW   |    | Diameter:<br>148 X 75 MM<br>Direction:CW             |
| 89018521  | BUICK LESABRE 02-05<br>Cadillac DeVille 02-05   | 20760618<br>22741027<br>25860468  | Chevrolet GMC Hummer Cadillac                        |
| BS-66626  |   | BS-66627F   |  |
|  | Diameter:<br>134 X 78 MM<br>Direction:CW  |  | Diameter:<br>151 X 70 MM<br>Direction:CCW            |
| 25776197  | Chevrolet Cobalt 2010-2005<br>Cherrolet HHR 2011-2006<br>Pontiac G5 2009-2007   | T82377C   | Chevrolet Onix Plus Turbo<br>Tracker 2020>           |
| BS-66628F   |   | BS-66631F   |  |
|  | Diameter:<br>150 X 65 MM<br>Direction:CCW   |  | Diameter:<br>MM<br>Direction:CCW                     |
| 96675858  | CHEVROLET SPARK GT 2012 2015  | 68037308AA  | Dodge Challenger 2008-2019<br>Chrysler 300 2008-2020 |

BLOWER MOTOR

| BS-66702T   |   | BS-66703   |   |
|---|---|--|---|
|    | Diamater:<br>145 X 92.5 MM<br>Direction: CW |     | Diamater:<br><br>Direction: CW  |
| 52498981  | Chevrolet S10                               | 52477152   | VENTILACAO BLAZER/S10   |
| BS-66704  |   | BS-66706   |   |
|    | Diamater:<br>120 X 84MM<br>Direction: CW    |     | Diamater:<br>165X70MM<br>Direction: CCW   |
| 52460703<br>15-80213  | CHEVROLET D20                               | 272700-5011<br>AY2727005471  | 道奇旅程/道奇复仇者<br>DODGE CALIBER 06-11年<br>DODGE avenger SXT 08-14<br>DODGE RAM 1500 2009-2014 |
| BS-66707  |   | BS-66714F  |   |
|  | Diamater:<br><br>Direction: CW              |  | Diamater:<br><br>Direction: CCW   |
| 52456662  | Chevrolet Monza<br>Kadett 1989>1998 -       | 68089108AA<br>68079477AB<br>68029719AB<br>68224166AB                                 | Dodge Durango 2016-2011<br>Chrysler Town & Country 2016-2008                              |
| BS-66723F   |   | BS-66730F  |   |
|  | Diamater:<br><br>Direction: CCW(RHD)        |   | Diamater:<br><br>Direction: CCW   |
|   | Chevrolet Captiva                           | 530.075  | Chevrolet Meriva 12V  |

BLOWER MOTOR

| BS-66733F   |  | BS-66738F   |  |
|---|--|---|--|
|    | Diamater:<br><br>Direction: CCW          |    | Diamater:<br><br>Direction: CCW          |
| 52484322  | Chevrolet Astra 1999><br>New Vectra 12 V |   | Chevrolet Agile<br>Montana2011> 12 Volts |
| BS-67401F   |  | BS-67402  |  |
|    | Diamater:<br><br>Direction: CCW          |    | Diamater:<br>148X70MM<br>Direction: CW   |
| 3010483<br>5096255AA<br>5073486AA   | DODGE RAM 1500-5500<br>JEEP GRAND        |   | GM                                       |
| BS-67405FBL   |  | BS-66819  |  |
|  | Diamater:<br><br>Direction: CCW          |  |  |
| 84392186  | Cadillac ATS ATSL CTS                    | 84392186<br>6441.K0<br>6441.K0<br>6441.BE 6441.<br>BF 6441.CH 6441.CN                 | Cadillac ATS ATSL CTS                    |

BLOWER MOTOR



| BS-66401FBL  |   | BS-66401BL  |   |
|--|---|---|---|
|  | Diameter:<br>166.5X70MM<br>Direction:CCW                                      |   | Diameter:<br>165X70MM<br>Direction:CW   |
| 87103-ON010<br>272600-0332<br>272600-0331                              | TOYOTACROWN<br>SEQUOIA, SIENNA REIZ<br>PRADO 丰田皇冠锐志                           | 87103-60390<br>87103-60480  | Lexus Is220d Is250 GS   |
| BS-66402   |   | BS-66402S   |   |
|  | Diameter:<br>165X70MM<br>Direction:CCW  |   | Diameter:<br><br>Direction:CW   |
| 87103-06090<br>87103-33090<br>87103-0E040<br>87103-60400<br>68232372AC | TOYOTA CAMRY(2002-2011)<br>TOYOTA HIGH LANDER<br>丰田凯美瑞 汉兰达<br>雷克萨斯ES350 ES240 |   | Toyota Corolla ALTIS 2010   |
| BS-66403   |   | BS-66403F   |   |
|  | Diameter:<br>146X65MM<br>Direction:CW   |   | Diameter:<br>146X65MM<br>Direction:CCW  |
| 74150M63J00  | TOYOTA YARIS(2007-2012)<br>SUZUKI / MARUTI<br>丰田雅力士                           | AV272700311<br>74150-62JA0<br>87103-52141<br>87103-0D170<br>87103-0D100 | TOYOTA YARIS(2007-2012)<br>TOYOTA Vios 2008<br>SUZUKI SX4<br>Suzuki Swift 2004<br>VISO 威驰 (08-13)<br>丰田雅力士 铃木雨燕 |
| BS-66404   |   | BS-66404F   |   |
|  | Diameter:<br>130X59MM<br>Direction:CW   |   | Diameter:<br>130X59MM<br>Direction:CCW  |
| 87103-26070<br>87103-26072<br>87103-26081<br>272700-0720               | TOYOTA COMMUTER<br>VIGO(Pickup Car)<br>TOYOTA HI-ACE 2015                     | 87103-26111<br>87103-26091  | VIGO(Pickup Car)  |

BLOWER MOTOR



| BS-66405   |   | BS-66405S   |   |
|--|---|---|---|
|  | Diameter:<br>152X70MM<br>Direction:CCW  |   | Diameter:<br><br>Direction:CCW  |
| 87103-02190<br>87103-OR020<br>272700-2103<br>87103-02210             | TOYOTA CORALLA(2009-2014)<br>TOYOTA RAV4<br>丰田卡罗拉 RAV4 雷凌 (自动)                                  | 87103-02261   | TOYOTA Corolla Fielder 2008   |
| BS-66406   |   | BS-66407BF  |   |
|  | Diameter:<br>150X75MM<br>Direction:CCW  |   | Diameter:<br><br>Direction:CCW  |
| 87103-YC050<br>87103-33050   | TOYOTA CAMRY(2003-2006)<br>LEXUS ES300  |   | TOYOTA HINO SING HIFECH 3M  |
| BS-66408A  |   | BS-66408AF  |   |
|  | Diameter:<br>148X75MM<br>Direction:CW   |   | Diameter:<br>148X75MM<br>Direction:CCW                                      |
| 87103-12050<br>74250-65D11   | TOYOTA corolla(2001-2007)<br>TOYOTA Rav4(1997-2000)<br>pick up(1989-1995)<br>Grand Vitara 99-02 | 87103-02050<br>87103-02320<br>88648-02360<br>87103-02370<br>87103-16040<br>87103-42020<br>87103-17020 | Mitsubishi MB657229<br>Mitsubishi MB657230<br>26-13982<br>Toyota/Lexus      |
| BS-66409   |   | BS-66409F   |   |
|  | Diameter:<br>150X75MM<br>Direction:CW   |   | Diameter:<br>150X75MM<br>Direction:CCW                                      |
| 194000-5151<br>194000-5102<br>194000-7381<br>MR398725<br>87103-33071 | Mitsubishi Pajero<br>Shogun 2000-2007<br>Land Rover Range Rover 1994-2002                       | 87103-60250<br>87103-35022<br>87103-33081   | TOYOTA Land cruiser<br>TOYOTA 4Runner(1996-)<br>TOYOTA LEXUS 470(1998-2007) |

BLOWER MOTOR



| BS-66413  |   | BS-66413F                  |  |
|---|---|----------------------------|--|
|   | Diameter:<br>109X79MM<br>Direction: CW(RHD)   |                            | Diameter:<br>109X79MM<br>Direction: CCW(LHD) |
| 87103-0D340   | TOYOTA ETIOS XS DSL<br>TOYOTA VISO 2014<br>TOYOTA HINO500(NEW)  | 87103-0D290<br>87103-0D360 | TOYOTA ECHO / YARIS /<br>VIOS 2013-2017      |
| BS-66413FB  |   | BS-66414                   |  |
|   | Diameter:<br>109X79MM<br>Direction: CCW(LHD)  |                            | Diameter:<br>150X75MM<br>Direction: CW (RHD) |
| 87103-37040   | BLOWER HINO 300<br>N04C XZU720 11 24V   | 7801A502                   | TOYOTA Harrier2.4L<br>MITSUBISHI Pajero(V90) |
| BS-66414F   |   | BS-66415F                  |  |
|   | Diameter:<br>150X75MM<br>Direction: CCW   |                            | Diameter:<br>150X75MM<br>Direction: CCW      |
| 87103-08090<br>72223AJ01A<br>19130001<br>72223AG06A | TOYOTA Sienna 201-2007<br>LEXUS RX330 2006<br>RX350 2009-2007<br>Cadillac CTS 2015-2011<br>Subaru Legacy 2014-2010<br>Outback 2014-2010 | 272700-0040<br>87103-60421 | TOYOTA VIOS AVANZA                           |
| BS-66418  |   | BS-66418H                  |  |
|   | Diameter:<br>Direction: CW  |                            | Diameter:<br>Direction: CW                   |
|   | TOYOTA Lnnova Crysta<br>Front Blower  | 87103-0K310                | TOYOTA Lnnova Crysta Blower                  |

BLOWER MOTOR



| BS-66420                                  |   | BS-66422F                  |  |
|---|---|----------------------------|--|
|   | Diameter:<br>140X70MM<br>Direction: CW  |                            | Diameter:<br>Direction: CCW                        |
| 87103-0C061<br>87103-28111<br>87103-0E070 | TOYOTA Highlander(2011-2013)<br>TOYOTA Sequoia(2008-2017)<br>TOYOTA Sienna(2011-2017) | 87103-0K130                | Toyota Hilux SR/SRV<br>SW4 2005>2008               |
| BS-66422                                  |   | BS-66423A                  |  |
|   | Diameter:<br>Direction: CW  |                            | Diameter:<br>148X75MM<br>Direction: CW(RHD)        |
| 88550-97501                               | DAIHATSU Hijet 2007 LE-S330V  | 87103-12060<br>87103-02080 | Toyota Corolla 2001-2007 RHD<br>Avensis, 2003-2008 |
| BS-66423AF                                |   | BS-66424F                  |  |
|   | Diameter:<br>148X75MM<br>Direction: CCW   |                            | Diameter:<br>150X70MM<br>Direction: CW             |
| 87103-12070                               | Toyota Corolla 2003>2006  | 162500-0890                | TOYOTA REVO  |
| BS-67303FBL                               |   | BS-66429FBL                |  |
|   | Diameter:<br>Direction: CCW   |                            | Diameter:<br>Direction: CCW                        |
| 8710375020<br>8710375021<br>8710376030    | Lexus CT200h (17-11)<br>Toyota Mirai (18-16)  | 116360-3200                | Toyota Hilux / SRV 2016> /<br>SW4 2008>2015        |

BLOWER MOTOR



|   |  |                            |  |
|---|--|----------------------------|--|
| <b>BS-66431FBL</b>                        |  | <b>BS-66433FBL</b>         |  |
|   | Diameter:<br>Direction:CCW                   |                            | Diameter:<br>Direction:CCW             |
| 87103-0C051<br>87103-0C050<br>87103-75021 | Toyota Sequoia 2008-2020<br>Sienna 2011-2020 | 87103-0E090<br>87103-58080 | 2019 Toyota Rav 4                      |
| <b>BS-66434BL</b>                         |  | <b>BS-66434FBL</b>         |  |
|   | Diameter:<br>Direction:CW (RHD)              |                            | Diameter:<br>Direction:CCW(LHD)        |
|   | LEXUS CT200                                  |                            | LEXUS CT200                            |
| <b>BS-66426</b>                           |  | <b>BS-66426F</b>           |  |
|   | Diameter:<br>140X86MM<br>Direction:CCW       |                            | Diameter:<br>140X86MM<br>Direction:CCW |
| 8710360421<br>(RHD)                       | Toyota CASE 丰田凯斯                             | 8710360421<br>(LHD)        | Toyota CASE 丰田凯斯                       |
| <b>BS-66427</b>                           |  | <b>BS-66428</b>            |  |
|   | Diameter:<br>130X70MM<br>Direction:CW        |                            | Diameter:<br>140X75MM<br>Direction:CW  |
|   | MTX SOLUNA                                   |                            | TOYOTA VIOS 2003                       |

BLOWER MOTOR



|   |   |   |  |
|---|---|---|--|
| <b>BS-66428F</b>                          |   | <b>BS-66432A</b>                            |  |
|   | Diameter:<br>140X75MM<br>Direction:CCW                        |   | Diameter:<br>Direction:CW  |
| 87103-04030<br>87103-52060                | TOYOTA ECHO 2000-2005<br>TOYOTA TACOMA 1995-2004              | 282500-1320                                 | TOYOTA DYNA Platform/Chassis   |
| <b>BS-66432AF</b>                         |   | <b>BS-66507F</b>                            |  |
|   | Diameter:<br>Direction:CCW                                    |   | Diameter:<br>145X64MM<br>Direction:CCW   |
| 282500-1010<br>87104-37120<br>116360-1480 | TOYOTA ZKDY2#/LY2#/RZY2#<br>TRY2#/TRU3#                       | 87103-12040                                 | Toyota Corolla 93-97   |
| <b>BS-66513</b>                           |   | <b>BS-66513F</b>                            |  |
|   | Diameter:<br>129X70MM<br>Direction:CW(RHD)                    |   | Diameter:<br>137X70MM<br>Direction:CCW(LHD)  |
| 87103-0K320                               | TOYOTA HILUX REVO(2015-2019)<br>HILUX 2GD<br>LANH INNOVA 2017 | 116360-3180<br>79310-THR-A41<br>87103-0K440 | TOYOTA HILUX SW4 SRX 2.8 2017<br>SUBARU CROSSTREK 2018-2019<br>HONDA CR-V 2017-2019<br>HONDA ODYSSEY 2018-2020<br>TOYOTA HILUX 2016-2019 |
| <b>BS-66514</b>                           |   | <b>BS-66514F</b>                            |  |
|   | Diameter:<br>148X75MM<br>Direction:CW                         |   | Diameter:<br>Direction:CCW   |
| 87103-08070<br>79220-TK8-A41              | TOYOTA Sienna 2005-2010<br>Honda Odyssey 2011-2017            | 79220-SHJ-A01<br>87103-42060                | TOYOTA RAV4 2004-2005  |

BLOWER MOTOR



|   |  |   |   |
|---|--|---|---|
| BS-66519  |  | BS-66904  |   |
|   | Diameter:<br>150X70MM<br>Direction: CW   |   | Diameter:<br>155X70MM<br>Direction: CW(RHD)   |
| 87103-52200   | TOYOTA   | 87103-0K100<br>87103-0K210<br>87103-26060<br>AE272700-0101<br>AE272700-0770 | TOYOTA Hilux SR5<br>第七代海拉克斯 奔跑者<br>TOYOTA Hiace 08<br>TOYOTA VIGO/MK6/MK7(2005-2014)<br>HONDA CR-Z(2011-2016) |
| BS-66904F   |  | BS-67304F   |   |
|   | Diameter:<br>155X70MM<br>Direction: CCW(LHD)   |   | Diameter:<br>Direction: CCW   |
| 87103-26110<br>87103-0K091<br>87103-0K092<br>87103-0K200<br>5292625<br>AE272700-5151<br>79310TJ5F02 | TOYOTA Hilux Pickup<br>第七代海拉克斯 奔跑者<br>TOYOTA Hiace 丰田海狮面包 (05-11)<br>TOYOTA INNOVA(FRONT) 伊诺瓦 (前)<br>TOYOTA Vigo | 87103-35060   | LEXUS GX470<br>TOYOTA 4RUNNER   |
| BS-66517F   |  | BS-66710F   |   |
|   | Diameter:<br>Direction: CCW  |   | Diameter:<br>Direction: CCW   |
| 79310-TET-H51<br>79310-TBA-A11  | HONDA CIVIC 16-  | 79310-SAD-M01   | HONDA Fit 2003>2008   |
| BS-66904F   |  |   |   |
|   | Diameter:<br>155X70MM<br>Direction: CCW  |   |   |
| 79310-T5H-H01<br>94767137   | HONDA CITY 锋范 (15-19)<br>FIT 飞度二厢 (15-19)<br>GREIZ 哥瑞 (16-17)<br>GIENIA 竞瑞(17-)                                  |   |   |

BLOWER MOTOR



|   |   |                                |  |
|---|---|--------------------------------|--|
| BS-66409                                    |   | BS-66410                       |  |
|   | Diameter:<br>150X75MM<br>Direction: CW                              |                                | Diameter:<br>155X75MM<br>Direction: CW       |
| 194000-5151                                 | HONDA LEGEN(1986-)  | 194000-0443                    | HONDA ACCORD2.2L<br>TOYOTA Tiger(2000-)      |
| BS-66411F                                   |   | BS-66419                       |  |
|   | Diameter:<br>150X75MM<br>Direction: CCW                             |                                | Diameter:<br>145X70MM<br>Direction: CW(RHD)  |
| 87103-60220<br>79310-S84-A01<br>87103-0C020 | TOYOTA Land Cruiser 100<br>LEXUS LX 470<br>HONDA Accord Odyssey MDX | 272700-1480<br>87103-12110     | HONDA AMAZE RHD                              |
| BS-66419F                                   |   | BS-66503                       |  |
|   | Diameter:<br>145X70MM<br>Direction: CCW                             |                                | Diameter:<br>150X70MM<br>Direction: CW (RHD) |
| 79310-T5R-A01                               | HONDA FIT 飞度 (15-20)<br>2016 Honda FIT 本田                           | 79310-TM0-G01<br>79310-TMO-G01 | HONDA FIT 飞度(09-14)<br>HONDA CITY 锋范(09-14)  |
| BS-66503F                                   |   | BS-66504                       |  |
|   | Diameter:<br>150X70MM<br>Direction: CCW                             |                                | Diameter:<br>Direction: CW (RHD)             |
| 79310-TFO-G01                               | HONDA FIT 飞度(09-14)   | Honda Accord 2003-2007 (G7)    |  |

BLOWER MOTOR



|  |  |   |  |
|--|--|---|--|
| <b>BS-66504F</b>   |  | <b>BS-66505</b>                                 |  |
|  | Diameter:<br>Direction:CCW (LHD)                           |   | Diameter:<br>150X75MM<br>Direction:CCW                                 |
| 79310-SDG-W01<br>79310-SDC-A01<br>79310-SHJ-A01<br>79310-SDG-O00 | HONDA ACURA(2004-2008)<br>HONDA ACCORD2.4<br>雅阁(2003-2007) | 79310-S84-A01                                   | HONDA ACCORD 2.3L(1999-2002)   |
| <b>BS-66506</b>  |  | <b>BS-66507</b>                                 |  |
|  | Diameter:<br>140X75MM<br>Direction:CCW                     |   | Diameter:<br>145X64MM<br>Direction:CCW                                 |
| 79310-S0X-A51<br>79310-SAA-003<br>79310-SXO-A01<br>194000-1060   | HONDA CITY (2003-2008)                                     | 79310-SR3-A01<br>87103-12030                    | HONDA CIVIC(1994-/<br>ACURA CL(1997-1999)<br>ACURA INTEGRA (1994-2001) |
| <b>BS-66508</b>  |  | <b>BS-66508F</b>                                |  |
|  | Diameter:<br>165X70MM<br>Direction:CCW                     |   | Diameter:<br>165X70MM<br>Direction:CCW                                 |
| 194000-1470  | HONDA CR-V 03<br>HONDA CV 2001                             | 79310-S5D-A01<br>79310-S5J-M01<br>79310-SCV-A01 | HONDA CR-V03<br>HONDA CV 2001  |
| <b>BS-66509</b>  |  | <b>BS-66509F</b>                                |  |
|  | Diameter:<br>140X85MM<br>Direction:CCW (RHD)               |   | Diameter:<br>140X85MM<br>Direction:CCW                                 |
| 194000-1060<br>79310-SAA-000                                     | HONDA CITY(2003-2008)<br>JAZZ 2006 1.3L                    | 79310-SAA-G01<br>79310-SAA-305                  | HONDA CITY(2003-2008)<br>HONDA Fit (2007-2008)<br>JAZZ                 |

BLOWER MOTOR



|   |  |   |   |
|---|--|---|---|
| <b>BS-66510F</b>  |  | <b>BS-66511</b>   |   |
|   | Diameter:<br>146X65MM<br>Direction:CCW                                       |   | Diameter:<br>165X70MM<br>Direction:CCW (RHD)  |
| 79310-SD4-013<br>39242-671-000<br>HD-B5402A 01919   | HONDA CITY(1990-1996)<br>Acura Integra Legend Prelude                        | 79310-T9A-F01   | HONDA ACURA CSX(2006-2011)<br>HONDA CIVIC(2006-2011)  |
| <b>BS-66511F</b>  |  | <b>BS-66512/BS-66014A</b>                                     |   |
|   | Diameter:<br>165X70MM<br>Direction:CCW                                       |   | Diameter:<br>165X70MM<br>Direction:CCW  |
| 79310-SNJ-A01<br>79310-SNK-A01<br>79310-SNA-A02<br>79310-SNA-A01<br>79310-SNK-K01   | HONDA ACURA CSX(2006-2011)<br>HONDA CIVIC(2006-2011)<br>HONDA CR-V (2002-06) |   | HONDA CRV(2008-/)   |
| <b>BS-66512F/BS-66706</b>   |  | <b>BS-66515</b>   |   |
|   | Diameter:<br>165X70MM<br>Direction:CCW                                       |   | Diameter:<br>Direction:CCW  |
| 79310-STK-A41<br>79310-SWW-G01<br>79310-TA0-A01<br>272700-5060<br>AY272700-5400 TD1161B10<br>87103-60330 68048903AA<br>68250220AB 87103-35100 | HONDA CRV(2008-/<br>Mazda CX-9 2007-2015<br>Honda New Civic 07               | 79310-TV1-E01   | HONDA CIVIC 12- /MK9  |
| <b>BS-66515F</b>  |  | <b>BS-66516F</b>  |   |
|   | Diameter:<br>Direction:CCW<br>小插头<br>165*71.5                                |   | Diameter:<br>Direction:CCW<br>大插头<br>165*71.5   |
| 79310-TS6-H01<br>TYC700257  | HONDA CIVIC 12-  | 79310-T2F-A01<br>79310-T0A-A01<br>79311-TR6-A71<br>VDO PM4038 | CAR MODEL Acura RDX 2017-2016<br>Honda Accord 2017-2013<br>Honda CR-V 2016-2012<br>Honda Civic 2015-2013 Coupe<br>Honda Civic 2015-2014 Sedan |

BLOWER MOTOR



| BS-66801                  |  | BS-66802F   |   |
|---------------------------|--|---|---|
|                           | Diameter:<br>140X81.4MM<br>Direction: CW         |   | Diameter:<br>149X85MM<br>Direction: CCW   |
| 27226-JE20A-A129          | NISSAN QASHQAI(2008-2013)<br>NISSAN X-TRAIL 日产逍客 | 27226-ED000<br>27226ED52A-A129<br>27226-E050A<br>27226-EE91A/C<br>VA502725-3510 | NISSAN TIIDA(2007-2016)<br>NISSAN VERSA(2007-2012)<br>NISSAN SYLPHY<br>骐达 颐达 轩逸 骊威 骏逸         |
| BS-66803A                 |  | BS-66803AF  |   |
|                           | Diameter:<br>146X65MM<br>Direction: CW           |   | Diameter:<br>146X65MM<br>Direction: CCW   |
| 8972119520<br>502725-0596 | NISSAN FRONTIER/HICOM(12V)                       | 8972316420<br>89721195305   | NISSAN FRONTIER/HICOM(12V)<br>Honda Passport<br>Isuzu Amigo                                   |
| BS-66804                  |  | BS-66804F   |   |
|                           | Diameter:<br>159X77MM<br>Direction: CW(RHD)      |   | Diameter:<br>159X77MM<br>Direction: CCW(LHD)  |
| 27226-JS60B               | NISSAN NAVARA(2008-2011)<br>纳瓦拉 D40              | 27226-JS71C<br>BA153-40620<br>BA153-40610<br>3163-8101078-30                    | NISSAN PICKUP(NEW)<br>NISSAN PATHFINDER<br>NISSAN XTERRA(2005-)<br>NISSAN NAVARA II<br>纳瓦拉D22 |
| BS-66804F-ZHX002          |  | BS-66805  |   |
|                           | Diameter:<br>159X77MM<br>Direction: CCW          |   | Diameter:<br>130X102MM<br>Direction: CW   |
| BA153-40620               | NISSAN Frontier /<br>Xterra 2013<br>日产皮卡         | 27226-1HM0A<br>27226-3AWOA-B009<br>27226-3AN0A<br>27226-1HB0A<br>RC.530.196     | NISSAN SUNNY(2010-2016)<br>NISSAN VERSA 12-16<br>日产新阳光  |

BLOWER MOTOR



| BS-66805F  |  | BS-66806  |   |
|--|--|---|---|
|  | Diameter:<br>130X102MM<br>Direction: CCW   |   | Diameter:<br>158X76MM<br>Direction: CW (RHD)  |
| 27226-3LM0A<br>27226-1HAOA                           | NISSAN MARCH/NV(2013-2017)<br>日产玛驰NV200  | 96554426  | NISSAN NAVARA 2005<br>PICKUP(OLD)<br>日产纳瓦拉  |
| BS-66806F  |  | BS-66807  |   |
|  | Diameter:<br>158X76MM<br>Direction: CCW (LHD)  |   | Diameter:<br>136X86MM<br>Direction: CW  |
| BA153-40520  | Nissan Frontier 2008>2012  |   | NISSAN TIIDA(2011-2016)<br>NISSAN SENTRA (2013-2018)<br>NISSAN Sylphy<br>NISSAN Blue bird<br>NISSAN Sylphy(new) |
| BS-66807F  |  | BS-66808  |   |
|  | Diameter:<br>136X86MM<br>Direction: CCW  |   | Diameter:<br>143X80MM<br>Direction: CW  |
| 272263DFOA-A129<br>27226-3SG0A                       | NISSAN TIIDA(2011-2016)<br>NISSAN SENTRA (2013-2018)<br>NISSAN Sylphy<br>NISSAN Blue bird<br>NISSAN Sylphy(new)<br>新骐达 新轩逸 新蓝鸟 | 27225-EN000<br>27225-ET10B<br>27225-ET10A<br>27225-JD00A<br>27225ET00A<br>615-50140 | NISSAN X-Trail T31(2007-2014)<br>Qashqai/Dualis(2006-2014)<br>NISSAN Sentar(2007-2012)<br>日产奇骏T31               |
| BS-66809F  |  | BS-66810F   |   |
|  | Diameter:<br>112.5X115.3MM<br>Direction: CCW   |   | Diameter:<br>120X74MM<br>Direction: CCW   |
| 272261KA0C<br>272261KA0A<br>273SY1KA0A<br>272261KA3A | NISSAN Juke F15 (2010-2018 NEW)  |   | NISSAN Datsun GO  |

BLOWER MOTOR



| BS-66821F                                 |   | BS-66812F  |   |
|---|---|--|---|
|   | Diameter:<br>Direction:CCW  |  | Diameter:<br>158X70MM<br>Direction:CCW      |
| 12100018                                  | NISSAN Pickup D22 K41 NP300<br>日产皮卡D22  |  | NISSAN郑州日产帅客                                |
| BS-66813                                  |   | BS-66813F  |   |
|   | Diameter:<br>146X70MM<br>Direction:CW   |  | Diameter:<br>146X70MM<br>Direction:CCW      |
| 27226-PA000-A084                          | NISSAN Quest(2004-2009)<br>NISSAN Sunny N16<br>日产老阳光  | 272226-8M510<br>27220-5M000<br>27220-4B000                             | NISSAN Quest(2004-2009)<br>NISSAN Sunny N16 |
| BS-66814F                                 |   | BS-66818F  |   |
|   | Diameter:<br>134X85MM<br>Direction:CCW  |  | Diameter:<br>Direction:CCW                  |
| 272261FC0B<br>T1015019K                   | NISSAN Cube(2009-2014)<br>JUKE(2011-2015)<br>LEAF(2011-2015)<br>MINI Cooper(2012-2015) INFINIT                        | 27226-4BG0B<br>27226-4BU0A<br>27226-4EM0A<br>27226-4EM3B               | NISSAN X-TRAIL T32 13-19<br>QASHQAI J11     |
| BS-66901                                  |   | BS-66901F  |   |
|   |   |  | Diameter:<br>161X69.5MM<br>Direction:CCW    |
| 27200-JA000<br>27220-CB000<br>27220-JK01A | NISSAN TENAN(2008-2012)<br>NISSAN MAXIMA(2009-2014)<br>NISSAN ALTIMA(2007-2014)<br>INFINITI QX70(2015-2000)<br>08款新天籁 | 272253TA1A<br>27200-JK61A<br>27225-JK60B<br>27225-JK60E<br>27225-AM611 | Infiniti EX35 Q50                           |

BLOWER MOTOR



| BS-66421F     |  | BS-66439      |                                |
|---------------|--|---------------|--------------------------------|
|               | Diameter:<br>130X75MM<br>Direction:CCW                 |               | Diameter:<br>Direction:CW      |
| 27220-2Y900   | VIVA SD NISSAN SENTRA                                  |               | Nissan Urvan E26 NV350 (Front) |
| BS-66439F     |  | BS-66442      |                                |
|               | Diameter:<br>Direction:CCW                             |               | Diameter:<br>Direction:CW      |
| 27220-3YF0A   | Nissan Urvan NV350 (LHD)                               | 27220-6A01A   | Nissan                         |
| BS-66604AK    |  | BS-66604FAK   |                                |
|               | Diameter:<br>Direction:CW                              |               | Diameter:<br>Direction:CCW     |
|               | ISUZU  | 79307-S6D-G03 |                                |
| BS-66612F     |  | BS-66443F     |                                |
|               | Diameter:<br>Direction:CCW                             |               |                                |
| MD11624392912 | Evaporator Box Fan Nissan<br>Frontier 2022 > - 12 Volt |               | SUZUKI                         |

BLOWER MOTOR



|                            |  |   |  |
|----------------------------|--|---|--|
| BS-66430/BS-66430F         |  | BS-66432B   |  |
|                            | Diameter:<br>Direction: CW   |   | Diameter:<br>Direction: CW                           |
| MIT ROSA                   |  | 282500-0212<br>282500-1000<br>AD-MC07<br>MC140941 | MITSUBISHI CANTER 1994-2001                          |
| BS-66432BF                 |  | BS-66605F   |  |
|                            | Diameter:<br>Direction: CCW  |   | Diameter:<br>158*72MM<br>Direction: CCW(LHD)         |
| 282500-0371<br>282500-1000 | MITSUBISHI BLENDER325A<br>TOYOTA CROWN<br>HINO-300 For<br>HINO J05C S05D S05C N04C | 7802A105  | Mitsubishi Triton L200<br>LHD<br>Pajero Dacar        |
| BS-66907/BS-66907X         |  | BS-66907F   |  |
|                            | Diameter:<br>Direction: CW(RHD)  |   | Diameter:<br>158X70MM<br>Direction: CCW(LHD)         |
| 7802A216                   | Lancer CY / ASX / Outlander  | 7842A076<br>7802A017<br>7802A217                  | MITSUBISHI OUTLANDER(2006-2013)<br>LANCER(2007-2014) |
| BS-66908                   |  | BS-66908F   |  |
|                            | Diameter:<br>Direction: CW(RHD)  |   | Diameter:<br>Direction: CCW (LHD)                    |
| 7802A310<br>CSA431D240     | MITSUBISHI L200 2016   | 7802A312<br>CSA431D241                            | MITSUBISHI L200 2016                                 |

BLOWER MOTOR



|  |  |  |  |
|--|--|--|--|
| BS-66909F                                  |  | BS-66414F  |  |
|  | Diameter:<br>Direction: CCW (LHD)  |  | Diameter:<br>150.5X75MM<br>Direction: CCW  |
| Mitsubishi L300 LHD                        |  | 272700-5290<br>872700-6060<br>T1017802F  | Subaru Impreza Forester(LHD)<br>WRX XC Crosstrek<br>MITSUBISHI Pajero(v90)2006     |
| BS-66604                                   |  | BS-66604F  |  |
|  | Diameter:<br>162X79MM<br>Direction: CW (RHD)   |  | Diameter:<br>162X79MM<br>Direction: CCW(LHD)                                       |
| 8981394270<br>272204JA0A<br>27220-4JA0A    | NISSAN 100 NX 1990-1994<br>ISUZU(Allnew)<br>D-MAX RHD(2012-2019)<br>V-CROSS MU-X<br>五十铃D-MAX<br>Chevrolet Trailblazer Colorado 2.8 | 98165412<br>8981654120<br>CB657229<br>CXA-2293<br>79307S6DG03<br>8973649790            | MOTOR CAIXA S10 C/AR(2012-)/<br>HINO NISSAN PICKUP<br>ISUZU D-MAX 2014-2017 MUX 瑞迈 |
| BS-66606                                   |  | BS-66606F  |  |
|  | Diameter:<br>158X75MM<br>Direction: CW(RHD)  |  | Diameter:<br>158X75MM<br>Direction: CCW(LHD)                                       |
| 27220-VB201<br>ME733724<br>IS-B0101A 10010 | ISUZU D-MAX(2002-2012)<br>ISUZU NPR(2002-2012)<br>ISUZU RODEO(2006-2012)<br>Nissan Patrol GU Y61 1997-2012                         | 27220-5E900<br>3L041-30370<br>27220-2Y900<br>27220-5E900<br>27220-VB002<br>27220-2Y910 | ISUZU D-MAX<br>Nissan Maxima Sentra A33<br>Infiniti I30 I35<br>日产千里马:              |
| BS-66421                                   |  | BS-66609FN   |  |
|  | Diameter:<br>Direction: CW   |  | Diameter:<br>141X81.5MM<br>Direction: CCW  |
| ISUZU CASONIC                              |  | 74250-64J10<br>74250-64J11<br>74250-76K10<br>74250-76K11<br>74250-76K12                | SUZUKI GRAND VITARA(2005-2013)<br>铃木维特拉  |

BLOWER MOTOR



| BS-66610                     |  | BS-66419            |  |
|------------------------------|--|---------------------|--|
|                              | Diamater:<br>Direction: CW                   |                     | Diamater: 145X70MM<br>Direction: CW  |
| 87103-0D340                  | SUZUKI SWIFT'12-17                           | 272700-1480         | SUZUKI SX4 S-CROSS HEATER#SSX 91<br>SUZUKI VITARA MK4 1.6(2015-<br>HONDA AMAZE RHD |
| BS-66419F                    |  | BS-66437            |  |
|                              | Diamater:<br>Direction: CCW                  |                     | Diamater:<br>Direction: CW(RHD)  |
| 74150-61MA0<br>79310-T5R-A01 | SUZUKI SX4 Ref N°<br>HONDA FIT 飞度 (15-20)    |                     | Suzuki Celerio   |
| BS-66440F                    |  | BS-66441F           |  |
|                              | Diamater:<br>Direction: CCW                  |                     | Diamater:<br>Direction: CCW  |
|                              | TATA PICKU/SUZUKI CARRY                      | 74150-57M00         | SUZUKI Jimny   |
| BS-66224F                    |  | BS-66438/ BS-66438F |  |
|                              | Diamater:<br>Direction: CCW                  |                     | Diamater:<br>Direction: CW/CCW   |
|                              | Chevrolet Celta/ Corsa<br>Prisma/ Suzuki Fun | /841859102145       | MAZDA TRIBUTE/ESCAPE/<br>Mazda Protege 1999-2003<br>Blower Motor                   |









BLOWER MOTOR



| BS-66514B                               |  | BS-66902/ BS-6902F  |   |
|---|--|---|---|
|   | Diamater:<br>Direction: CW   |   | Diamater: 158X70MM<br>Direction: CW/CCW                   |
|   | Mazda 3 2014-2018 (BM ,Skyactiv)<br>Mazda CX-5<br>Toyota Fortuner 2004-2015 (Rear)<br>Toyota Innova 2005-2015 (Rear) | 872700-0361<br>872700-0362<br>GS1D-61-B10/                          | MAZDA 6(2010-2015)<br>一汽奔腾B50 B70 X80 B90 X40/<br>M8,CX-5 |
| BS-66903                                |  | BS-66903F   |   |
|   | Diamater: 146X76MM<br>Direction: CW  |   | Diamater: 146X76MM<br>Direction: CCW                      |
| 272700-0040<br>72223-AG000<br>HD-60-048 | MAZDA 3  | 872700-0701<br>872700-0371<br>872700-0700<br>KD4561B10<br>DD2F61B10 | MAZDA 3 (2014 2015 2016)                                  |
| BS-66913                                |  | BS-67302  |   |
|   | Diamater: 150X70MM<br>Direction: CW  |   | Diamater:<br>Direction: CW                                |
| 1A08-61-B10                             | MAZDA  | BBM461B10   | MAZDA3  |
| BS-66518F                               |  | BS-66910  |   |
|   | Diamater:<br>Direction: CCW  |   | Diamater:<br>Direction: CW                                |
| 72210-KG000<br>72210-KG001              | SUBARU Stella 2009   | 88550-B2100<br>116340-9751  | daihatsu  |

BLOWER MOTOR



| BS-66301F   |  | BS-66302F  |   |
|---|--|--|---|
|    | Diameter:<br>153X74.7MM<br>Direction:CCW                         |    | Diameter:<br>147X75MM<br>Direction:CCW                    |
| 97113-2H000<br>F00S33F012   | HYUNDAI SANTA,ELANTRA(2006-)<br>KIA SPECTRA(2004-2009)           | TYC700222<br>PM9372<br>75867   | 97113-2d010<br>97116-24951<br>9713-2c000                  |
|   |  |  | HYUNDAI ELANTRA (2001-2006)<br>HYUNDAI ACCECT (2000-2002) |
|   |  |  | TYC700127<br>TYC700117<br>PM9194                          |
| BS-66302  |  | BS-66306   |   |
|    | Diameter:<br>147X75MM<br>Direction:CCW                           |    | Diameter:<br>148X75MM<br>Direction:CCW(RHD)               |
| 97109-3D000<br>HY3126102  | HYUNDAI SONATA TERRACAN<br>(1998-2006)<br>KIA OPTIMA (2003-2006) | TYC700119<br>TYC700118<br>35106  | 97113-2Y500   |
|   |  |  | 2014 KIA SPORTAGE HYUNDAI IX35                            |
| BS-66306F   |  | BS-66307   |   |
|  | Diameter:<br>148X75MM<br>Direction:CCW                           |  | Diameter:<br>Direction:CCW                                |
| 97113-2Y000   | 现代 HYUNDAI SONATA KIA K5   |  | 现代 HYUNDAI  |
| BS-66308F   |  | BS-66309   |   |
|  | Diameter:<br>151*74MM<br>Direction:CCW                           |  | Diameter:<br>Direction:CCW                                |
|   | 现代雅坤特Hyundai Accent (16-12)                                      | 971111W100   | Kia Rio 2012-2017   |

BLOWER MOTOR



| BS-66309F   |  | BS-66310  |  |
|---|--|---|--|
|    | Diameter:<br>148*74MM<br>Direction:CCW           |    | Diameter:<br>110*78MM<br>Direction: CW |
| 97113-2P000<br>971111W080<br>97113-2P700  | 起亚索兰托/智跑/新佳乐<br>SORENTO/SPORTAGE R<br>NEW LARENS | 97113-B9000   | HYUNDAI GRAND I10 2015 2017            |
| BS-66311F   |  | BS-66312  |  |
|    | Diameter:<br>Direction:CCW                       |    | Diameter:<br>Direction: CW             |
| 97113-H800  | Hyundai HB20 / Creta 2020><br>KIA RIO 2018-LHD   | TYC700246<br>97113-2K000  | Kia Soul 2011-2013                     |
| BS-66400  |  | BS-66400F   |  |
|  | Diameter:<br>Direction:CCW                       |  | Diameter:<br>Direction:CCW             |
| 97109-3D000   | 现代索纳塔, 福特  | 97113-3K000<br>97113-2E060  | 14 TUCSON SONATA NF/NCF<br>14款途胜、御翔、领翔 |

BLOWER MOTOR



BS-66920/BS-66920F



Diameter:  
Direction: CW/CCW

BS-66921



Diameter:  
Direction: CW

Proton Gen2/Persona Patco12V

Proton Saga BLM  
Sanden C/W Wheel  
12V

BS-66909



Diameter:  
Direction: CW

BS-66909F



Diameter:  
Direction: CCW

Proton Saga Denso  
12V

wira Denso  
12V

BLOWER MOTOR



BS-77037



SL-18A7-65S02



BS-77019BDJ-AK

BS-77103A

BS-77103ABL

BS-66520F

BS-66046

BS-77035BBL-260

BLOWER MOTOR









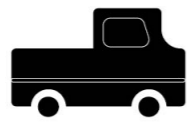

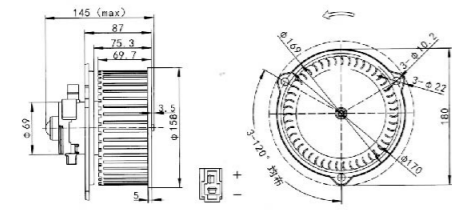

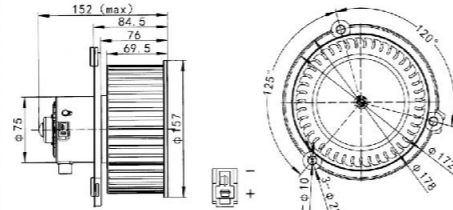

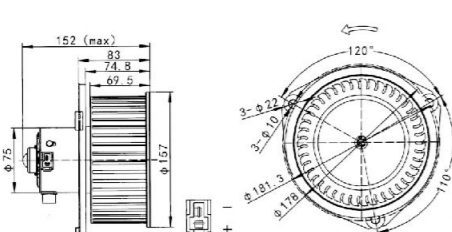
|   |   |  |  |
|---|---|--|--|
| BS-66721  |   | BS-66721F  |  |
|    | Diameter:<br>Direction: CW  |     | Diameter:<br>Direction: CCW  |
| AH222796  | Ventilador da Caixa Evaporadora da Máquina Colheitadeira John Deere STS9470/ STS9570 STS9670 12 Volts                                     |  |  |
| BS-66722  |   | BS-66715F  |  |
|    | Diameter:<br>Direction: CW  |    | Diameter:<br>Direction: CCW  |
|   | NEW HOLLAND T4.105 T5.115   | 261B84 RE162771  | John Deere RE208336 RE162771 - 26-19992  |
| BS-66716  |   | BS-66724F  |  |
|  | Diameter:<br>Direction: CW  |   | Diameter: 150X70MM<br>Direction: CW  |
| RE237675  | John Deere 7815 / 7230 / 7225   | ACW3145020   | Ventilador da Caixa Evaporadora Máquina Trator Valtra Série A4/ A94/ A104/ A114/ A124/ A134/ A144 12 Volts |
| BS-66726  |   | BS-66727F  |  |
|  | Diameter:<br>Direction: CW  |  | Diameter:<br>Direction: CCW  |
| 87107380  | Ventilador da Caixa Evaporadora da Máquina Trator Case Magnum 260/ 290/ 315/ 340/ 380/ 400/ Steiger 420/ 470/ 500/ 540/ 580/ 620 12 Volts | AH220407   | John Deere STS9470/ STS9570 STS9670/ STS9770 12 Volts  |

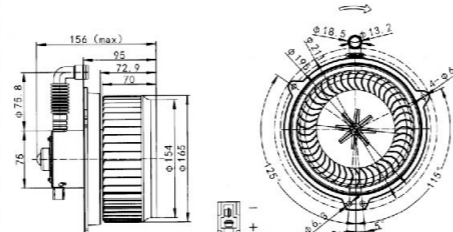
BLOWER MOTOR

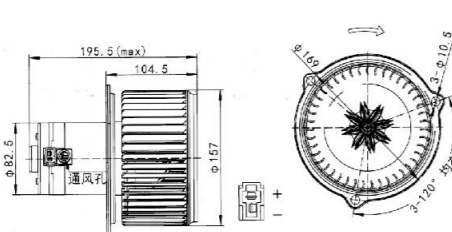
|   |   |   |  |
|---|---|---|--|
| BS-66728F   |   | BS-66729F   |  |
|    | Diameter:<br>Direction: CCW   |    | Diameter: 150X70MM<br>Direction: CW  |
| AT365430 365431   | Ventilador da Caixa Evaporadora da Máquina Pá Carregadeira John Deere 544K/ 624K/ 644K/ 724K 24 Volts | A0440144 AH003136   | Ventilador da Caixa Evaporadora da Máquina Trator LS Plus 80/ 90/ 100 12 Volts |
| BS-77027A   |   | BS-77030A   |  |
|    |   |    | Diameter:<br>Direction: CW   |
| 82002761  | nova Massey Ferguson 8940 / 2388 / 2399 / Trator New Holland TM / TL / 12 volts                       |   | 12V  |
| BS-66705  |   | BS-66632F   |  |
|  | Diameter:<br>Direction: CW  |  | Diameter:<br>Direction: CCW  |
| 7787-869445   | MACK Trucks   | 3543H9631   | Mack Truck CXU 2008-2015 Mack CHU 2008-2010, CXP 2007                          |
| BS-66110F   |   | BS-66110  |  |
|  | Diameter:<br>Direction: CCW   |  | Diameter:<br>Direction: CW   |
| 72348364  | Tracteur JOHN DEERE   | 72348365  | Tracteur JOHN DEERE  |

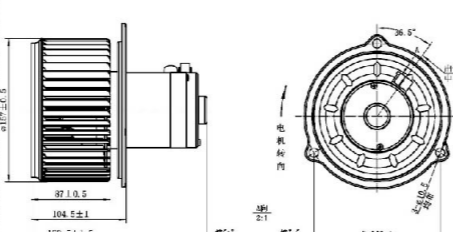
BLOWER MOTOR

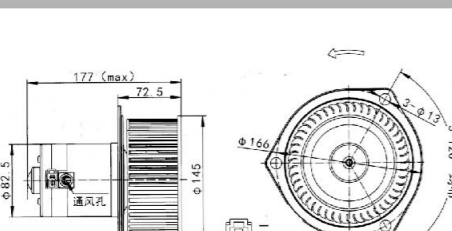

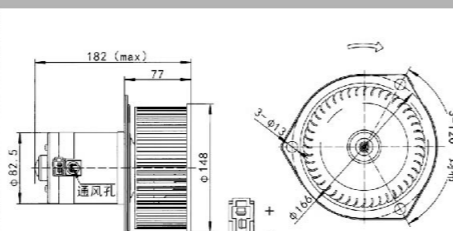







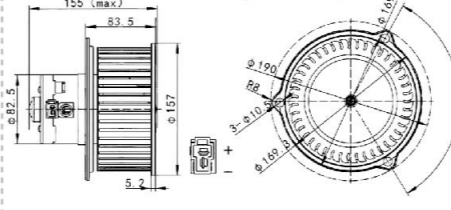

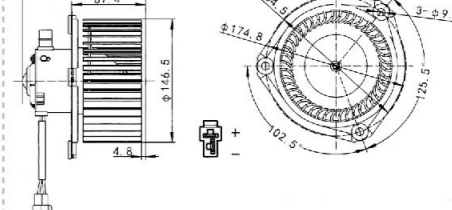

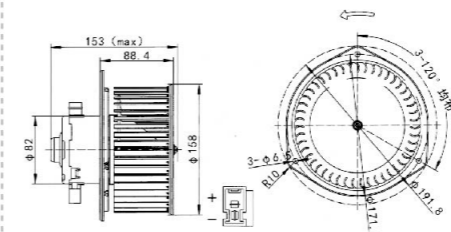

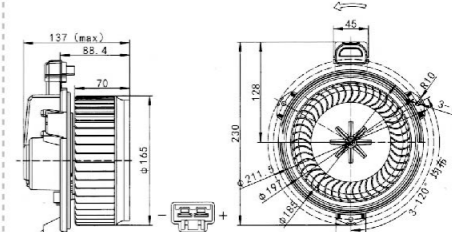
|  |   |
|--|---|
| <p>BS-66000</p>       | <p>BS-66001</p>        |
| <p>小松200-6<br/>KOMATSU PC200-6</p> <p>VOLTAGE:24V<br/>CURRENT:≤6A<br/>TUM SPEED:≥2800RPM</p>   | <p>日立200-5/200-6<br/>HITACHI EX200-5<br/>200-6</p> <p>VOLTAGE:24V<br/>CURRENT:≤7A<br/>TUM SPEED:≥3200RPM</p>  |
| <p>BS-66002</p>       | <p>BS-66003</p>        |
| <p>神钢 200-6<br/>KOBELCO SK200-6</p> <p>VOLTAGE:24V<br/>CURRENT:≤7A<br/>TUM SPEED:≥3200RPM</p>  | <p>ND116340-3860<br/>小松 200-7<br/>KOMATSU PC200-7</p> <p>VOLTAGE:24V<br/>CURRENT:≤8A<br/>TUM SPEED:≥3200RPM</p>   |
| <p>BS-66008</p>   | <p>BS-66008F</p>   |
| <p>日立450/小松200-7老款<br/>HITACHI EX450/PC200-7</p> <p>VOLTAGE:24V<br/>CURRENT:≤10A<br/>TUM SPEED:≥2700RPM</p>  |   |
| <p>BS-66009</p>   | <p>BS-66010</p>    |
| <p>1474834<br/>卡特 E320<br/>CAT E320</p> <p>VOLTAGE:24V<br/>CURRENT:≤5A<br/>TUM SPEED:≥3100RPM</p>  | <p>卡特 E330C<br/>CAT E330C</p> <p>VOLTAGE:24V<br/>CURRENT:≤5A<br/>TUM SPEED:≥3100RPM</p>   |

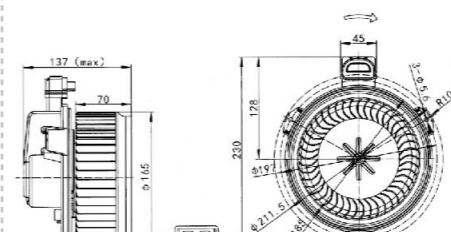
BLOWER MOTOR

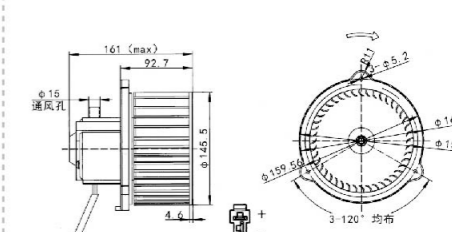
BLOWER MOTOR

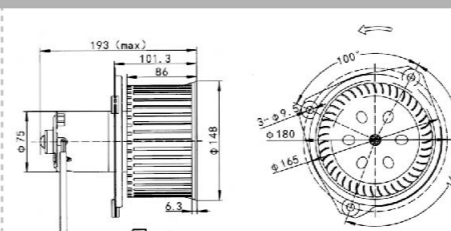

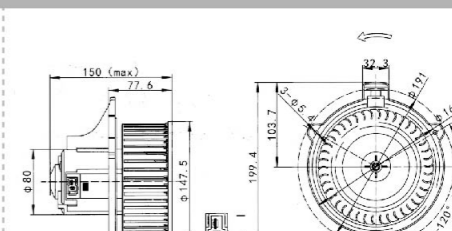
|  |  |
|--|--|
| <p>BS-66011</p>        | <p>BS-66012</p>        |
| <p>卡特 E320C<br/>CAT E320C</p> <p>VOLTAGE:24V<br/>CURRENT:≤5A<br/>TUM SPEED:≥3100RPM</p>  | <p>卡特 312C/小松-5<br/>CAT 312C/KOMATSU PC-5</p> <p>VOLTAGE:24V<br/>CURRENT:≤6A<br/>TUM SPEED:≥3000RPM</p>  |
| <p>BS-66012C</p>       | <p>BS-66013</p>        |
| <p>卡特 307C/308C<br/>CAT 307C/308C</p> <p>VOLTAGE:24V<br/>CURRENT:≤8A<br/>TUM SPEED:≥3100RPM</p>  | <p>小松200-8<br/>KOMATSU PC200-8</p> <p>VOLTAGE:24V<br/>CURRENT:≤11A<br/>TUM SPEED:≥2650RPM</p>  |
| <p>BS-66014B</p>   | <p>BS-66015B</p>   |
| <p>245-7839<br/>卡特 330D<br/>CAT 330D</p> <p>VOLTAGE:24V<br/>CURRENT:≤11A<br/>TUM SPEED:≥2650RPM</p>  | <p>11N690700<br/>现代-7 (正叶轮)<br/>HYUNDA R-7</p> <p>VOLTAGE:24V<br/>CURRENT:≤7.5A<br/>TUM SPEED:≥3200RPM</p>   |
| <p>BS-66016</p>    | <p>BS-66017</p>    |
| <p>加藤/住友<br/>KATO HD 820<br/>SUMITOMO</p> <p>VOLTAGE:27V<br/>CURRENT:≤8A<br/>TUM SPEED:≥3200RPM</p>  | <p>大宇 220-5<br/>DAEWOO DH 220-5</p> <p>VOLTAGE:24V<br/>CURRENT:≤7A<br/>TUM SPEED:≥3500RPM</p>  |



BS-66018

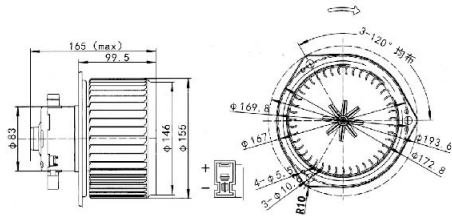
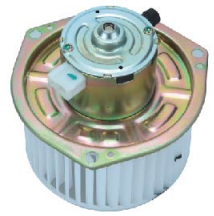

日立 120  
HITACHI 120

VOLTAGE:24V  
CURRENT:≤8A  
TUM SPEED:≥2800RPM

BS-66019

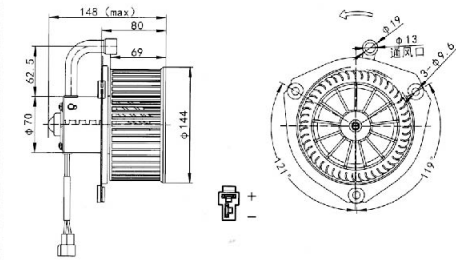

小松 60-7  
KOMATSU 60-7

VOLTAGE:24V  
CURRENT:≤7A  
TUM SPEED:≥3200RPM

BS-66020

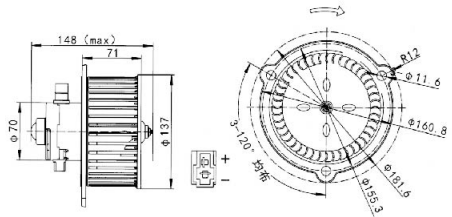

小神钢  
KOBELCO

VOLTAGE:24V  
CURRENT:≤4A  
TUM SPEED:≥3000RPM

BS-66021

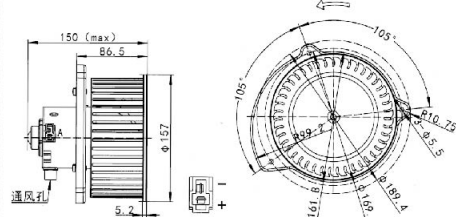

日立 200-3  
HITACHI 200-3

VOLTAGE:24V  
CURRENT:≤7A  
TUM SPEED:≥3200RPM

BS-66022F

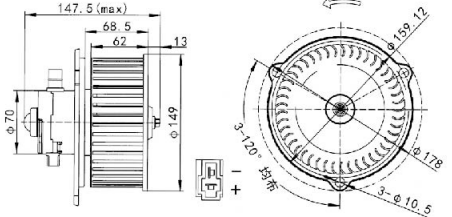

久保田KUBOTA 161/163  
洋马 YANMAR

VOLTAGE:12V  
CURRENT:≤7A  
TUM SPEED:≥2600RPM

BS-66023

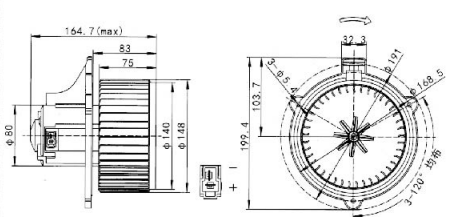

DX380/龙工/DS900  
奇瑞卡迪

VOLTAGE:24V  
CURRENT:≤6.3A  
TUM SPEED:≥2800RPM

BS-66024F

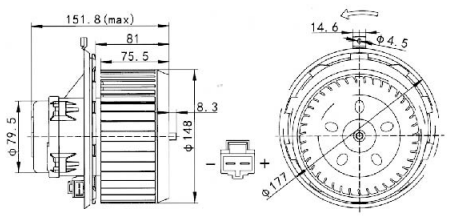

卡特 305.5E/307新款  
CAT 305.5E/307 NEW

VOLTAGE:12V  
CURRENT:≤12A  
TUM SPEED:≥2800RPM

BS-66032H

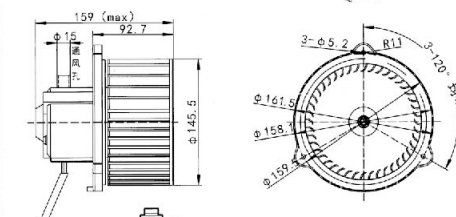

11N6-90700DW  
R210LC-7  
R250LC-7

现代-7 (反叶轮)  
HYUNDAI R-7

VOLTAGE:24V  
CURRENT:≤7.5A  
TUM SPEED:≥3200RPM



BS-66036F

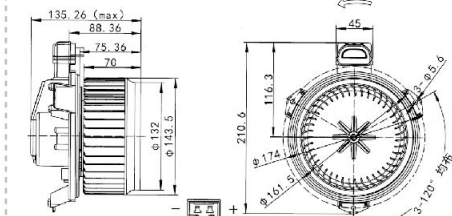

神钢 60-8/久保田新款  
KOBELCO SK60-8/KUBOTA

VOLTAGE:12V  
CURRENT:≤12.5A  
TUM SPEED:≥2880RPM

BS-66040F

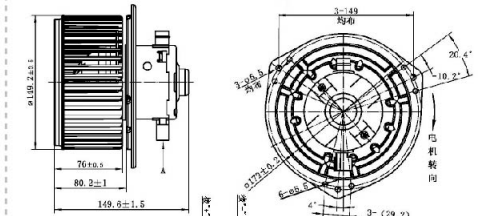

3639457

神钢SK200-10  
佳友A6/卡特349E

VOLTAGE:24V  
CURRENT:≤7.5A  
TUM SPEED:≥3100RPM

BS-66041F

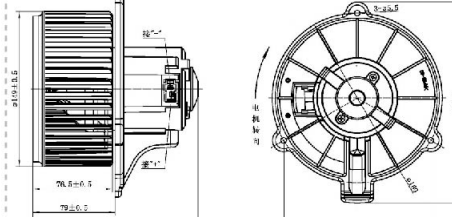

大宇DX/K1002206

VOLTAGE:  
CURRENT:≤  
TUM SPEED:≥

BS-66042A

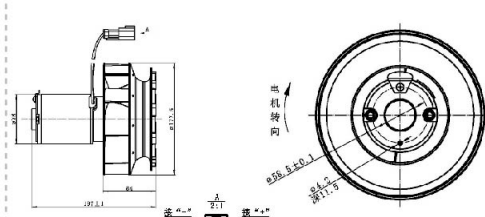

168-2313 505678D1  
358-7085 304-8965

Caterpillar Esteira DG5 12V  
VOLTAGE:12V  
CURRENT:≤22A  
TUM SPEED:≥3800RPM

BS-66042B

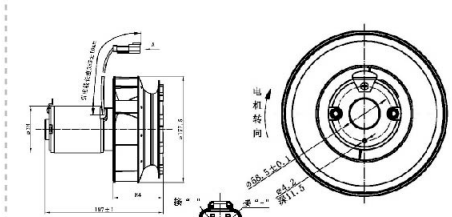

268-8792 2688792

CAT 950H 950G 962H

VOLTAGE:12V  
CURRENT:≤12A  
TUM SPEED:≥3800RPM

BS-66043

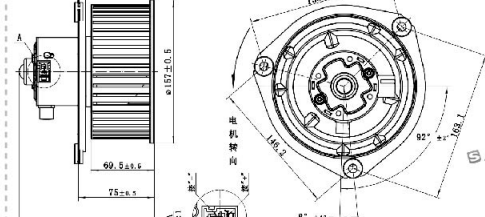

大神钢 UT实力工程车24V

VOLTAGE:24V  
CURRENT:≤7.5A  
TUM SPEED:≥3200RPM

BS-66043F

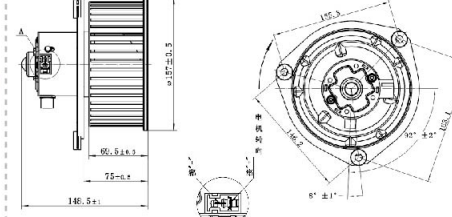

三菱拖头货车车24V

VOLTAGE:  
CURRENT:≤  
TUM SPEED:≥

BS-66045

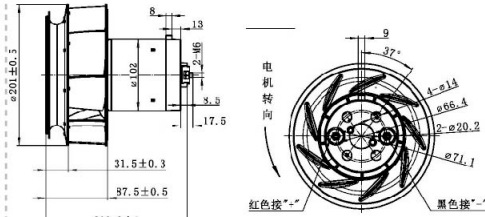

324-6125 466-7341

卡特彼勒 140M 844k  
MD6200 621H 990K 773F

VOLTAGE:24V  
CURRENT:≤10A  
TUM SPEED:≥3600RPM

BLOWER MOTOR

BLOWER MOTOR



Excavator series

BS-66064

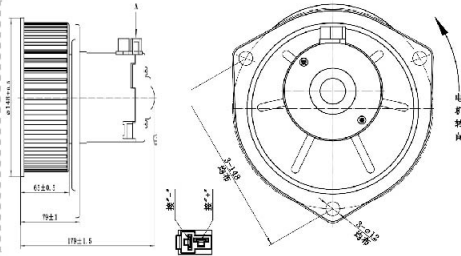

162500-7191

日野321/卡特320

VOLTAGE:24V  
CURRENT:≤7.5A  
TUM SPEED:≥3200RPM

BS-66065

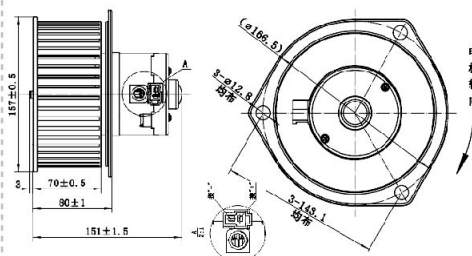

卡特320B

VOLTAGE:24V  
CURRENT:≤7.5A  
TUM SPEED:≥3200RPM

BS-66033

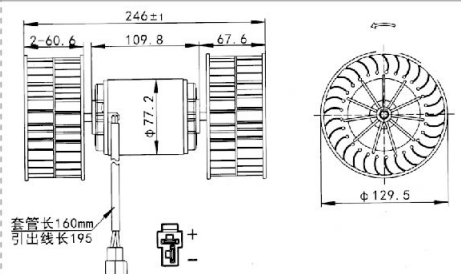

现代-9/龙工60  
临工  
HYUNDA R-9

VOLTAGE:24V  
CURRENT:≤7.5A  
TUM SPEED:≥3800RPM

BS-77003H

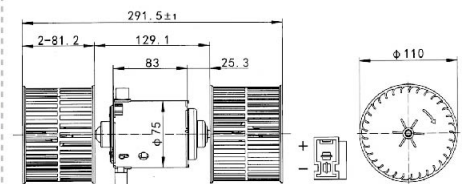

日立 70  
HITACHI 70

VOLTAGE:24V  
CURRENT:≤7.5A  
TUM SPEED:≥3800RPM

BS-77004H

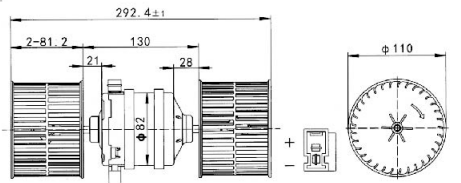

神钢 200-8  
KOBELCO SK200-8

VOLTAGE:24V  
CURRENT:≤6.5A  
TUM SPEED:≥3600RPM

BS-77005

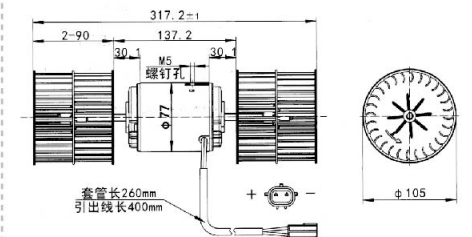

沃尔沃 360  
VOLVO 360

VOLTAGE:24V  
CURRENT:≤7A  
TUM SPEED:≥3700RPM

BS-77005A

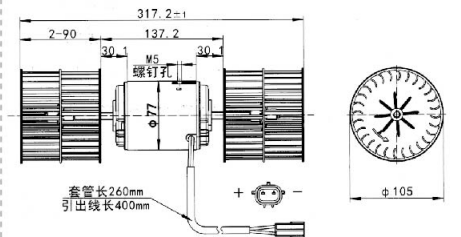

现代 60-7  
HYUNDAI 60-7

VOLTAGE:12V  
CURRENT:≤7A  
TUM SPEED:≥3700RPM

BS-77006A

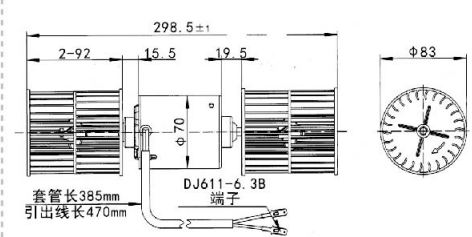

大宇小挖  
DAEWOO

VOLTAGE:12V  
CURRENT:≤6A  
TUM SPEED:≥3700RPM

Excavator series



BS-77007A

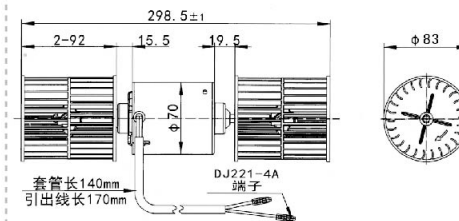

现代 60-7  
HYUNDAI 60-7

VOLTAGE:12V  
CURRENT:≤7A  
TUM SPEED:≥3700RPM

BS-77008

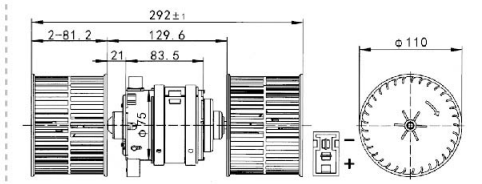

小松装载机  
KOMATSU HM450

VOLTAGE:24V  
CURRENT:≤7.5A  
TUM SPEED:≥3800RPM

BS-77011B

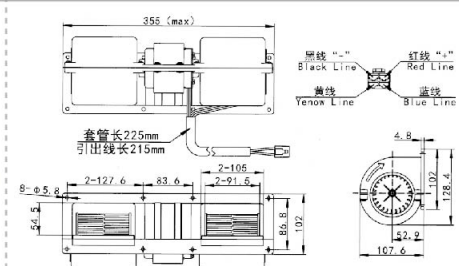

柳工820/三一重工  
雷沃85

VOLTAGE:24V  
CURRENT:≤7A  
TUM SPEED:≥3800RPM

BS-77015A/BS-77015B

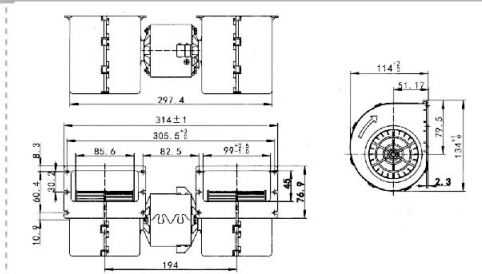

玉柴/山河智能  
SUNWARD

VOLTAGE:12V  
CURRENT:≤7A  
TUM SPEED:≥3800RPM

BS-77016

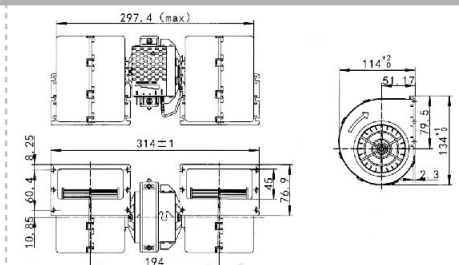

通用型 272  
UNIVERSAL 272  
S:三档 F: 四档

VOLTAGE:24V  
CURRENT:≤6A  
TUM SPEED:≥3580RPM

BS-77017B

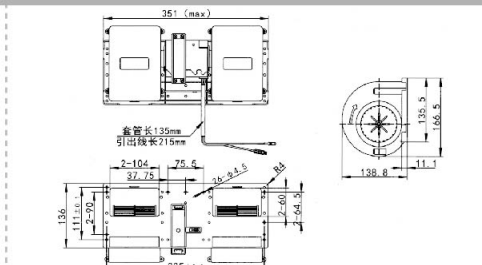

金杯海狮  
HIAICE

VOLTAGE:24V  
CURRENT:≤11.5A  
TUM SPEED:≥3750RPM

BS-77019BF

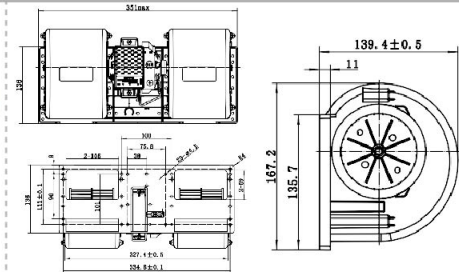

龙工  
VOLTAGE:24V  
CURRENT:≤3.0/4.5/6.5/10A  
TUM SPEED:≥1650/2300/2950/3500RPM

BS-77019B-CAT

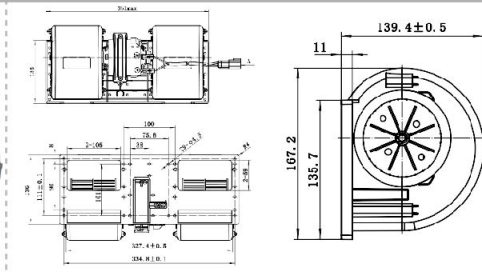
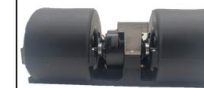

CTP69465415  
265867









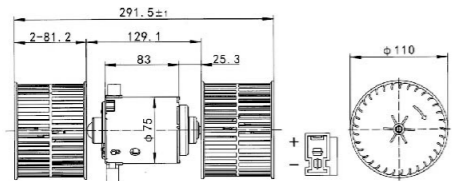

CAT

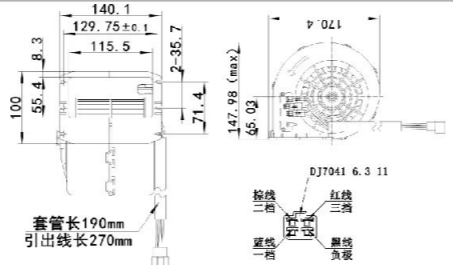
BLOWER MOTOR

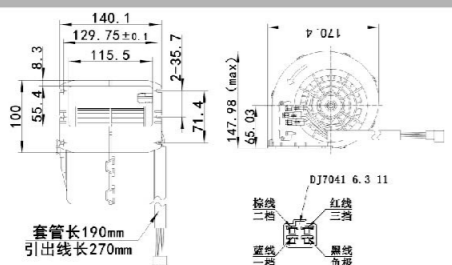
BLOWER MOTOR

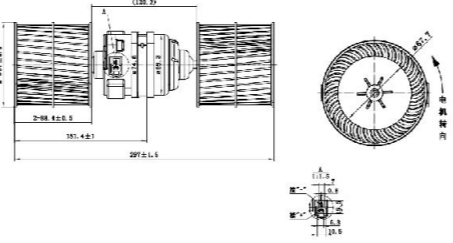











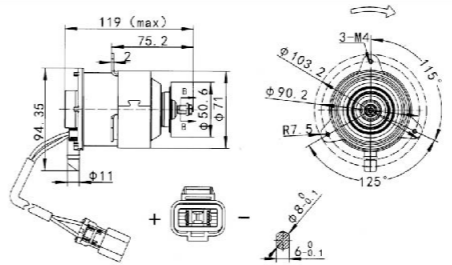

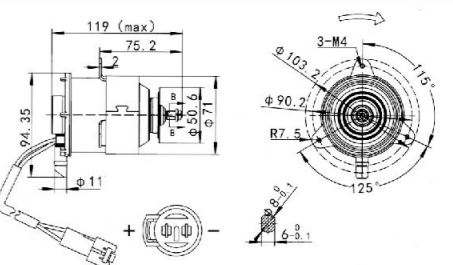

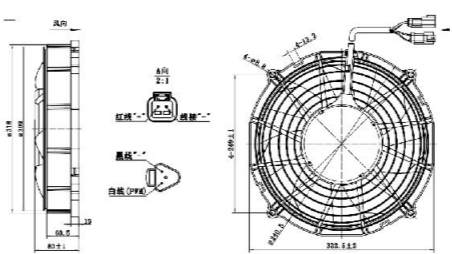
Excavator series

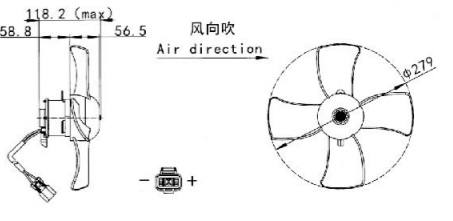
|   |   |
|---|---|
| <p>BS-77022H</p>   | <p>BS-77023A</p>   |
| <p>神钢超8<br/>KOBELCO</p> <p>VOLTAGE:24V<br/>CURRENT:≤7.5A<br/>TUM SPEED:≥3800RPM</p>   | <p>6401529E</p> <p>新款龙工/同力/新能源</p> <p>VOLTAGE:12V<br/>CURRENT:≤11A<br/>TUM SPEED:≥380RPM</p>  |
| <p>BS-77023B</p>   |                    |
| <p>新款龙工/同力/新能源</p> <p>VOLTAGE:24V<br/>CURRENT:≤11A<br/>TUM SPEED:≥380RPM</p>  | <p>Ônibus Sistema Denso 2<br/>Eixos - 24 Volts</p>  |
| <p>BS-77101</p>   | <p>BS-66005B</p>   |
| <p>神刚-8新款</p>   | <p>龙工215/厦工822</p>  |
| <p>BS-66005BF</p>   | <p>BS-66039B</p>   |
| <p>大宇新款</p>   | <p>徐工新款</p>   |

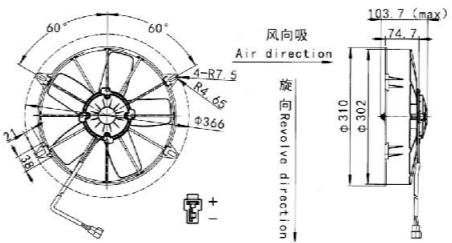
BLOWER MOTOR

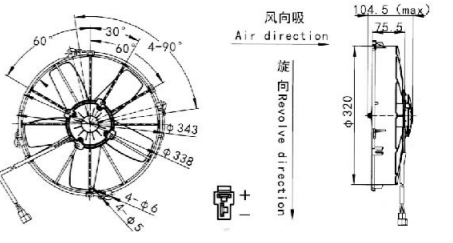
Excavator series

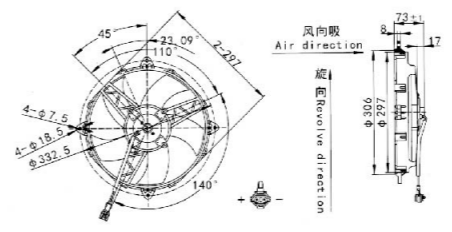

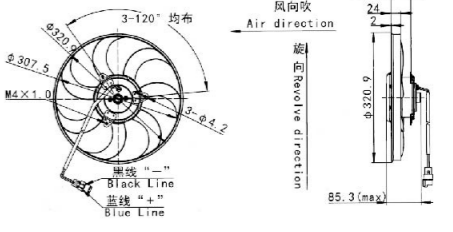
|  |  |
|--|--|
| <p>BS-55030方插</p>      | <p>BS-55030圆插</p>      |
| <p>卡特/小松/五十铃 (方插)<br/>CAT/KOMATSU/ISUZU</p> <p>VOLTAGE:24V<br/>CURRENT:≤4.8A<br/>TUM SPEED:≥2250RPM</p>  | <p>卡特/小松/五十铃 (圆插)<br/>CAT/KOMATSU/ISUZU</p> <p>VOLTAGE:24V<br/>CURRENT:≤4.8A<br/>TUM SPEED:≥2250RPM</p>  |
| <p>BS-88024BL</p>      | <p>BS-88023</p>        |
| <p>510-8095</p> <p>卡特320GC/GC系列</p>  | <p>卡特电子扇<br/>CAT</p> <p>VOLTAGE:24V<br/>CURRENT:≤5A<br/>TUM SPEED:≥2200RPM</p>   |
| <p>BS-88001A</p>   | <p>BS-88003A</p>   |
| <p>神刚 SK60 (吸风)<br/>KOBELCO SK60</p> <p>VOLTAGE:12V<br/>CURRENT:≤8A<br/>TUM SPEED:≥2850RPM</p>   | <p>竹内 电子扇<br/>(吸风)</p> <p>VOLTAGE:12V<br/>CURRENT:≤8A<br/>TUM SPEED:≥2800RPM</p>   |
| <p>BS-88010</p>    | <p>BS-88011</p>    |
| <p>尼桑 UD电子扇<br/>NISSAN UD</p> <p>VOLTAGE:24V<br/>CURRENT:≤6A<br/>TUM SPEED:≥2800RPM</p>  | <p>大宇 DH80-7<br/>DAEWOO DH80-7</p> <p>VOLTAGE:24V<br/>CURRENT:≤7A<br/>TUM SPEED:≥2600RPM</p>   |

BLOWER MOTOR



Heavy Truck

|                           |                                    |  |  |
|---------------------------|------------------------------------|--|--|
| BS-66629BL                |                                    | BS-66630FBL                            |  |
|                           | Diameter:<br>Direction: CW         |  | Diameter:<br>Direction: CCW  |
| VCC3500003<br>VCC929709R  | NEW FREIGHTLINER<br>CASCADIA (福莱纳) | W205700800<br>CM676433                 | KENWORTH/PETERBILT   |
| BS-77025                  |                                    | BS-77025AWH                            |  |
|                           |                                    |  |  |
| 3161927                   | 卡特彼勒/沃尔沃 CAT 24V                   | 3946686<br>351034171                   | VOLVO TRUCK 12V (1996-2006)  |
| BS-66671B                 |                                    | BS-67305BL                             |  |
|                           | Diameter:<br>Direction: CW         |  | Diameter:<br>Direction: CW   |
|                           | Ford Cargo 2007/ 24 volts          | G150010510<br>2318730                  | Fan of the DAF XF480 / XF530 2021<br>Truck Evaporator Box> - 24 Volts              |
| BS-67102BF                |                                    | BS-67103B                              |  |
|                           | Diameter:<br>Direction: CCW        |  | Diameter:<br>Direction: CW   |
| A0038300108<br>0038300108 | BENZ AXOR TRUCK 24V                | 9130451223<br>0008200908<br>9130451223 | Volkswagen/ Mercedes Benz 2726/<br>2423/ 2428/ 1620/ 1622/<br>1318/ 1718/ 24 volts |

BLOWER MOTOR



Heavy Truck

|  |  |   |  |
|--|--|---|--|
| BS-67105BF   |  | BS-67107B/ BS-66408B  |  |
|  | Diameter:<br>Direction: CCW  |   | Diameter:<br>Direction: CW   |
|  | Mercedes Benz 24V  | A0008200908   | Volkswagen Mercedes Benz   |
| BS-77062   |  | BS-77063  |  |
|  | Diameter:<br>104X63.4MM<br>Direction:  |   |  |
| 81619300042<br>8157216<br>8EW009160-021<br>0018300208<br>0130111116                    | MAN F 90, F 90 UNTERFLUR<br>L 2000, M 2000 L, M 90<br>VOLVO FL 10, FL 12, FL 4<br>FL 6, FL 7, FLC 09.85- | 0130111184<br>1357713<br>1401436<br>1495692                                     | Scania<br>Série 4 1998>2008 24V  |
| BS-77064   |  | BS-77065  |  |
|  | Diameter:<br>114X58MM<br>Direction:  |   |  |
| A0038300508<br>0130101616<br>8EW351029-041   | BENZ Actros Mp2 / Mp3  | 21639688<br>DS676244  | MOTOR VENTILAÇÃO CAMINHÃO<br>VOLVO 24V 2002>> 2 EIXOS /<br>COM TURBINA / COM CARENAGEM |
| BS-77066   |  | BS-77067  |  |
|  | Diameter:<br>Direction:  |   | Diameter:<br>129X60MM<br>Direction:  |
| A0008306308<br>0028308408<br>013006302<br>8EW351024-481<br>8EW009160491<br>A0008306308 | Benz Actros 2010   | 81619300055<br>3090909<br>001 830 0308<br>81619300055<br>A0018300308<br>3090909 | MAN, BENZ, VOLVO   |

BLOWER MOTOR



Heavy Truck

|  |  |   |   |
|--|--|---|---|
| BS-77080   |  | BS-77081BL                                    |   |
|  | Diameter:<br>129X60MM<br>Direction:                  |   | VOLTAGE:24V<br>CURRENT:≤12.5A<br>TUM SPEED:≥3400RPM     |
| 21639688   | Volvo FH 2002> 24 volts                              | 1854876<br>1854877<br>7737080301<br>A16700500 | SCANIA  |
| BS-77084A  |  | BS-77090DZ                                    |   |
|  |  |   |   |
| 32729820   | vaporadora Máquina<br>Valtra / Valmet BH180 12 Volts | 0018308708<br>130063514<br>8EW009158-071      | BENZ ACTROS   |
| BS-77078A  |  | BS-66131BF                                    |   |
|  | Diameter:<br>Direction:                              |   | Diameter:<br>Direction:CCW                              |
| 6618306408                                       | 奔驰MB100 前暖风电机  |   | VOLVO FH460/RENAUIT 24V RHD                             |
| BS-66131BWK                                      |  | BS-66132B                                     |   |
|  |  |   | Diameter:<br>Direction:CW                               |
| 7482349000<br>7484223449<br>82349000<br>84223449 |  | VO84479335                                    | Evaporator Box Fan Truck<br>Volvo FH/FM 2020> - 24 Volt |

BLOWER MOTOR









Heavy Truck

|                                      |  |   |   |
|--------------------------------------|--|---|---|
| BS-66633FBL-WK                       |  | BS-66633FBL                             |   |
|                                      | Diameter:<br>Direction:CCW                                   |   | Diameter:<br>Direction:CCW                      |
| A0048303908                          | MERCEDES-BENZ Actros<br>Drops MP4 TRUCK                      | A0038307108                             | MERCEDES-BENZ Actros<br>Drops MP4 TRUCK         |
| BS-67301BL                           |  | BS-66737                                |   |
|                                      | Diameter:<br>Direction:CW                                    |   | Diameter:<br>Direction:CW                       |
| 2546341                              | Scania Novembro 2018   | 16466693<br>16466693S<br>A21R23.8101178 | Двигатель отопителя<br>Газель NEXT для ГАЗ, GAZ |
| BS-66156BL                           |  | BS-66305BL                              |   |
|                                      | Diameter:<br>MM<br>Direction:CW                              |   | Diameter:<br>Direction:CW                       |
| 8EW351034251<br>BOA94350<br>85104207 | Freightliner Coronado FL50<br>FL60 FL70<br>Volvo V N系列 02-17 | VCCT77421A                              | 福莱纳FRTLINER 美系重卡                                |
| BS-77151                             |  | BS-77106                                |   |
|                                      | Diameter:<br>Direction:                                      |   | Diameter:<br>Direction:                         |
| 351034131                            | Freightliner Century Class 96-04                             | 0028308408                              | BENZ ACTROS MP2/MP3                             |

BLOWER MOTOR



## Heavy Truck

|   |   |  |  |
|---|---|--|--|
| BS-66803BF  |   | BS-66414BF   |  |
|          | Diamater:<br>146X65MM<br>Direction:CCW  |    | Diamater:<br>150.5X75MM<br>Direction:CCW |
| 8972119540<br>502725-0704   | ISUZU NPR 66(24V)<br>ISUZU ELF NQR(2003-2009)<br>HONDA PASSPORT(1994-1999)24V | 116360-1480  | ISUZU DECA FVM240/FMR130                 |
| BS-66057  |   | BS-66417B  |  |
|          | Diamater:<br><br>Direction:CW<br>24V  |     | Diamater:<br><br>Direction:CW            |
| 4HK1 8-98047451-0 24V<br>Volt Fan Blower Motor<br>8980474510 for<br>ISUZU ELF Truck NQR75 | 庆铃700P ISUZU 700P   | 272700-6010  | HINO 300 LHD                             |
| BS-66417BF  |   | BS-66414B  |  |
|        | Diamater:<br><br>Direction:CCW  |   | Diamater:<br>150.5X75MM<br>Direction:CW  |
| 272700-6020   | HINO 300 RHD  | 272700-5330<br>272700-5650   | FOM175 HINO DUTRO<br>300 HINO J08CN/M    |
| BS-66051  |   | BS-66051F  |  |
|        | Diamater:<br><br>Direction:CW<br>24V  |  | Diamater:<br><br>Direction:CCW<br>24V    |
| 87104-1100  | 广汽日野700 HINO 500/700  | S8710-41200<br>282500-1371   | HINO MEGA (RHD)                          |

BLOWER MOTOR

## Heavy Truck

|   |                                      |   |   |
|---|--------------------------------------|---|---|
| BS-66432B   |                                      | BS-66432BF  |   |
|    | Diamater:<br><br>Direction:CW        |    | Diamater:<br><br>Direction:CCW  |
| 282500-0212<br>282500-1000<br>AD-MC07<br>MC140941                                     | MITSUBISHI CANTER 1994-2001          | 282500-0371<br>282500-1000  | MITSUBISHI BLENDER325A<br>TOYOTA CROWN HINO-300 For<br>HINO J05C S05D S05C N04C |
| BS-66901B   |                                      | BS-66901BF  |   |
|    | Diamater:<br><br>Direction:CW        |    | Diamater:<br><br>Direction:CCW  |
| 尼桑 UD重卡 24V   |                                      | 27211-0Z00A 尼桑 UD重卡 24V   |   |
| BS-66004  |                                      | BS-66004L   |   |
|  | Diamater:<br><br>Direction:CW<br>24V |  | Diamater:<br><br>Direction:CW   |
| 尼桑UD搅拌车 NISSAN UD   |                                      |   |   |
| BS-66131BFWK  |                                      | BS-66026S   |   |
|  | Diamater:<br><br>Direction:          |  | Diamater:<br><br>Direction:CW   |
| 84223451  | VOLVO FH4 RHD                        | NISSAN truck 天龙右舵   |   |

BLOWER MOTOR

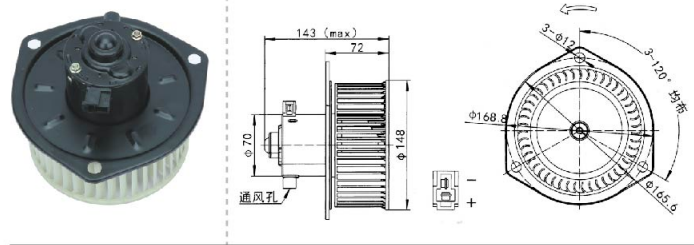
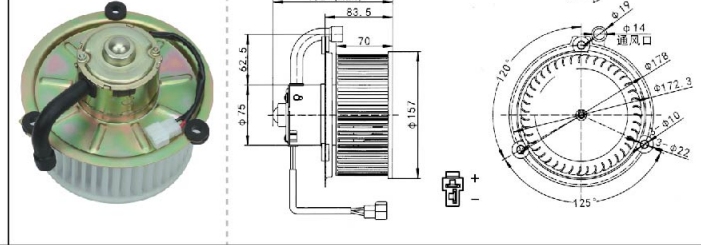
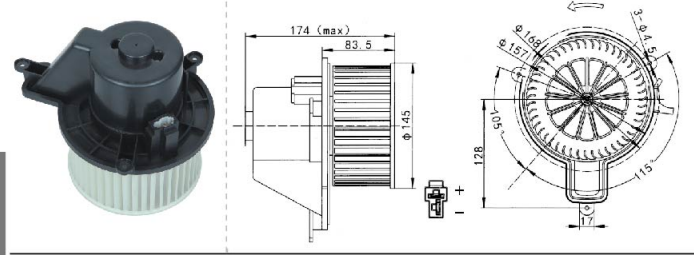
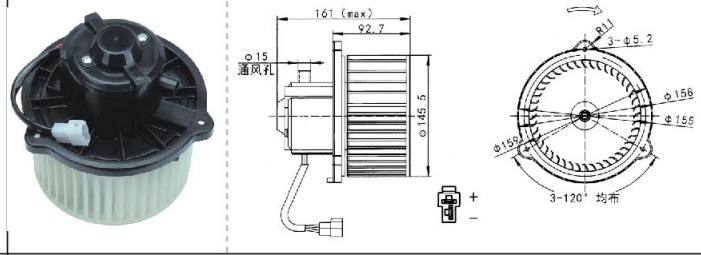
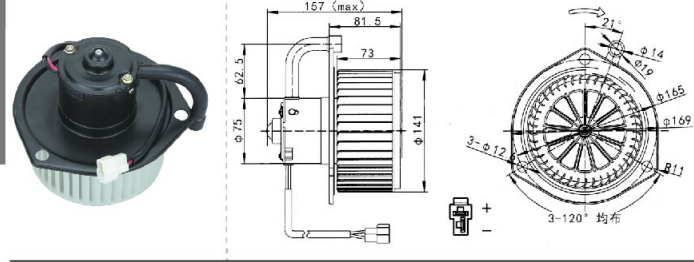
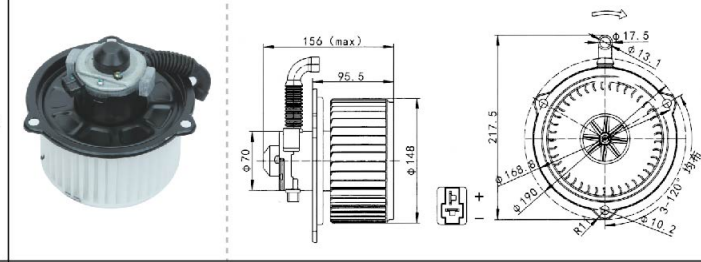
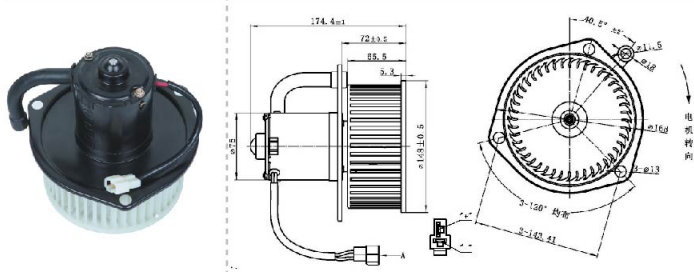
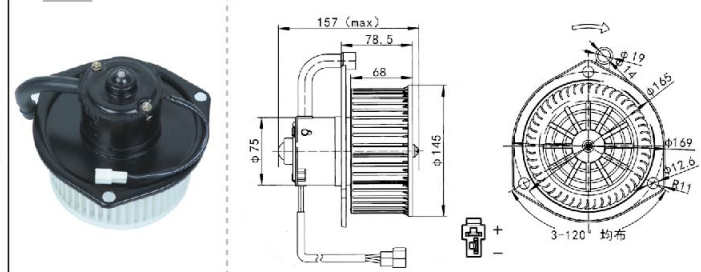

Heavy Truck

|  |  |
|--|--|
| <p>BS-66006</p>    | <p>BS-66025</p>      |
| <p>华菱<br/>CAMC</p> <p>VOLTAGE:24V<br/>CURRENT:≤7A<br/>TUM SPEED:≥3400RPM</p>                       | <p>H0811020023A0<br/>欧曼<br/>AUMAN</p> <p>VOLTAGE:24V<br/>CURRENT:≤10A<br/>TUM SPEED:≥3600RPM</p>       |
| <p>BS-66026</p>    | <p>BS-66028</p>      |
| <p>天龙/天锦/大力神<br/>TIANLON</p> <p>VOLTAGE:24V<br/>CURRENT:≤10A<br/>TUM SPEED:≥3700RPM</p>            | <p>格尔发<br/>JAC</p> <p>VOLTAGE:24V<br/>CURRENT:≤9A<br/>TUM SPEED:≥3350RPM</p>                           |
| <p>BS-66030</p>  | <p>BS-66051</p>    |
| <p>一汽解放J5-J6<br/>FAW J5-J6</p> <p>VOLTAGE:24V<br/>CURRENT:≤10A<br/>TUM SPEED:≥3500RPM</p>          | <p>282500-1371<br/>广汽日野 700<br/>HINO 700</p> <p>VOLTAGE:24V<br/>CURRENT:≤9A<br/>TUM SPEED:≥3150RPM</p> |
| <p>BS-66052</p>  | <p>BS-66054</p>    |
| <p>151</p> <p>VOLTAGE:24V<br/>CURRENT:≤8A<br/>TUM SPEED:≥3500RPM</p>                               | <p>奥威 金刚<br/>FAW</p> <p>VOLTAGE:24V<br/>CURRENT:≤8A<br/>TUM SPEED:≥3500RPM</p>                         |

BLOWER MOTOR

Heavy Truck

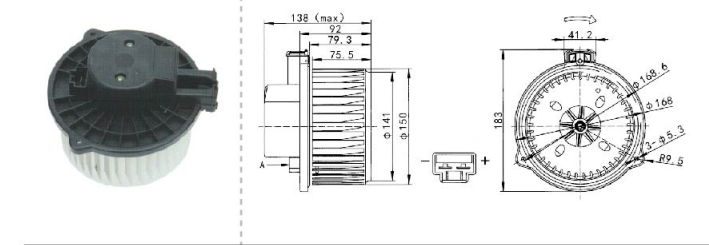
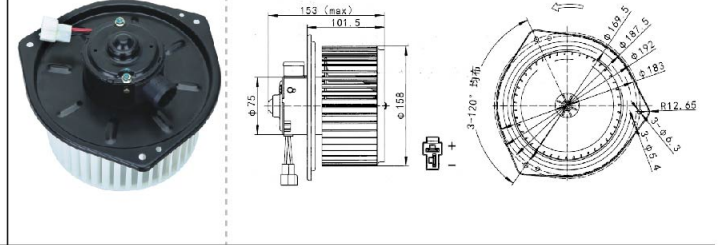
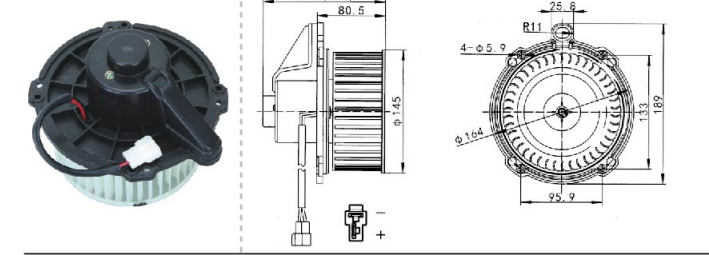
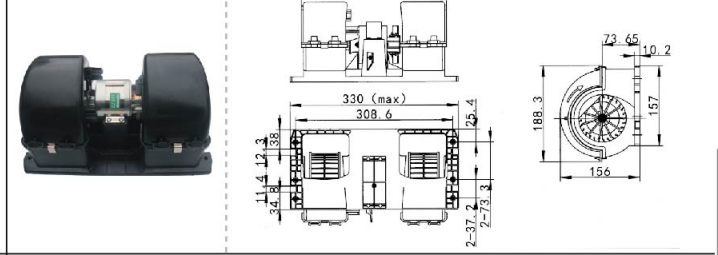
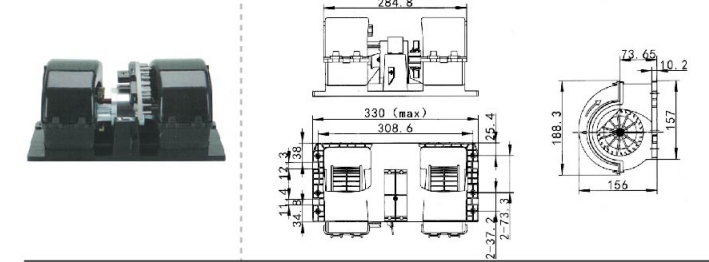
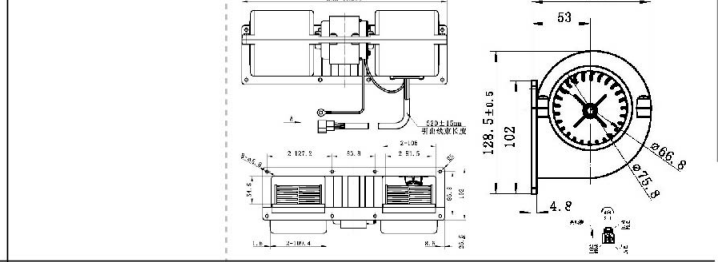
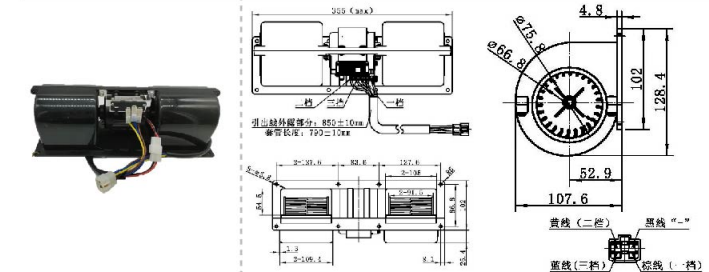
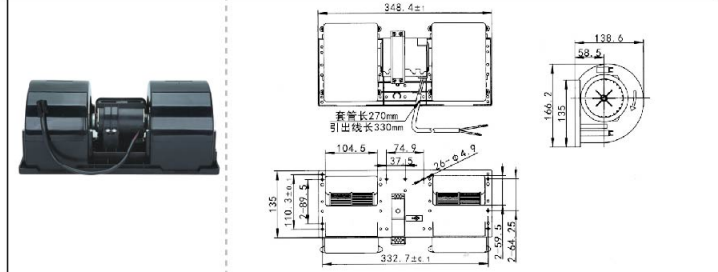

|   |   |
|---|---|
| <p>BS-66057</p>        | <p>BS-66059</p>      |
| <p>庆铃700P<br/>ISUZU 700P</p> <p>VOLTAGE:24V<br/>CURRENT:≤12A<br/>TUM SPEED:≥3100RPM</p>                   | <p>奥龙/重汽M56/浩瀚/<br/>新斯太尔<br/>CNHTC M56</p> <p>VOLTAGE:24V<br/>CURRENT:≤10A<br/>TUM SPEED:≥2900RPM</p>   |
| <p>BS-66061</p>        | <p>BS-77009</p>      |
| <p>江淮轻卡<br/>JAC</p> <p>VOLTAGE:24V<br/>CURRENT:≤6A<br/>TUM SPEED:≥3000RPM</p>                             | <p>豪沃 A7<br/>HOWO A7</p> <p>VOLTAGE:24V<br/>CURRENT:≤17A<br/>TUM SPEED:≥3500RPM</p>                     |
| <p>BS-77009DZ</p>    | <p>BS-77011DB</p>  |
| <p>沃尔沃卡车<br/>VOLVO TRUCK</p> <p>VOLTAGE:24V<br/>CURRENT:≤17A<br/>TUM SPEED:≥3500RPM</p>                   | <p>奥龙<br/>AOLONG</p> <p>VOLTAGE:24V<br/>CURRENT:≤6.5A<br/>TUM SPEED:≥390RPM</p>                         |
| <p>BS-77011WDZA</p>  | <p>BS-77012</p>    |
|   | <p>德龙 F3000<br/>DELOG F3000</p> <p>VOLTAGE:24V<br/>CURRENT:≤11A<br/>TUM SPEED:≥3900RPM</p>              |

BLOWER MOTOR



# Heavy Truck

BS-77013

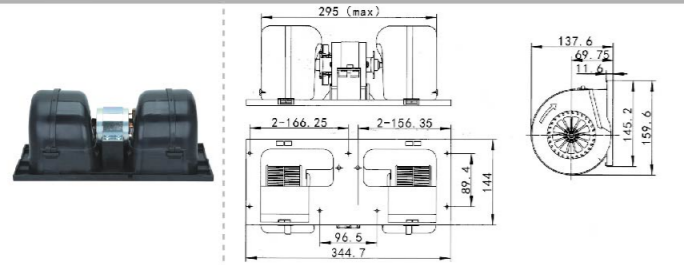

金王子  
CNHTC

VOLTAGE:24V  
CURRENT:≤5.6A  
TUM SPEED:≥5300RPM

BS-77014

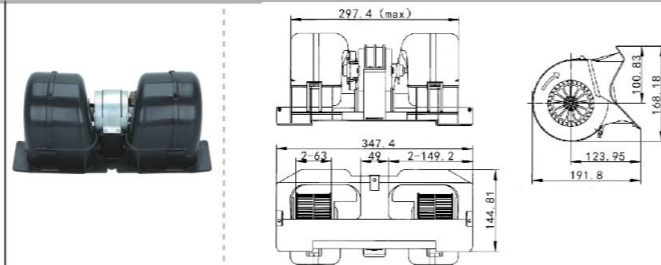

斯太尔王/豪沃  
老款三一重工  
STEYR/HOWO/SANY

VOLTAGE:24V  
CURRENT:≤4.1A  
TUM SPEED:≥4700RPM

BS-77051



奔驰 欧III  
BENZ

VOLTAGE:24V  
CURRENT:≤11A  
TUM SPEED:≥3200RPM

BS-77053D

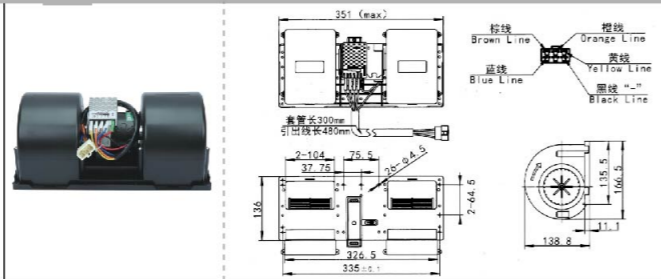

大运重卡 电动  
DAYUN

VOLTAGE:24V  
CURRENT:≤10.3A  
TUM SPEED:≥3960RPM

BS-77053S

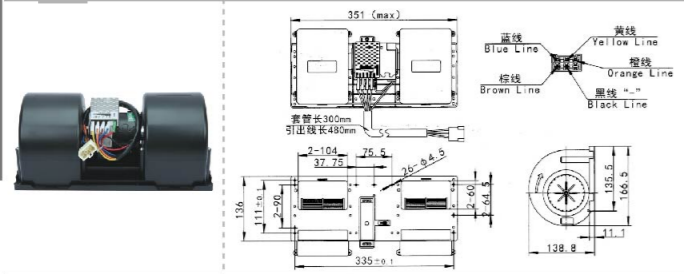

大运重卡 手动  
DAYUN

VOLTAGE:24V  
CURRENT:≤9.3A  
TUM SPEED:≥3890RPM

BS-77054DZ

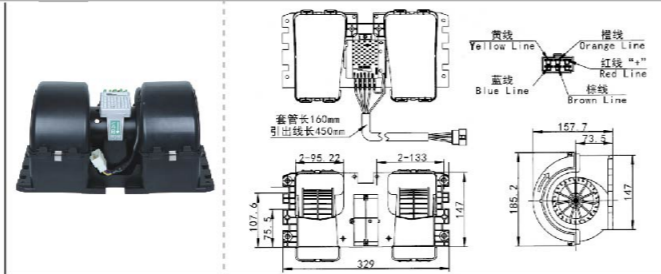

德龙新M3000  
DELONG M3000

VOLTAGE:24V  
CURRENT:≤14A  
TUM SPEED:≥3630RPM

BS-77056

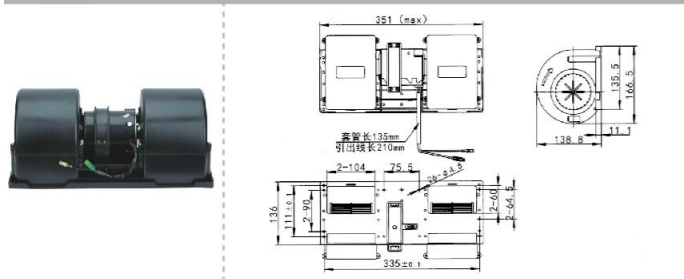

霸龙 507  
BALON 507

VOLTAGE:24V  
CURRENT:≤9.3A  
TUM SPEED:≥3890RPM

BS-77057

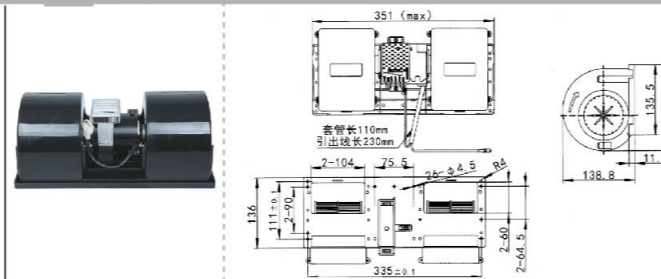

新奥龙 F2003  
AOLON F2003

VOLTAGE:24V  
CURRENT:≤11.7A  
TUM SPEED:≥2390RPM

# Heavy Truck



BS-77058

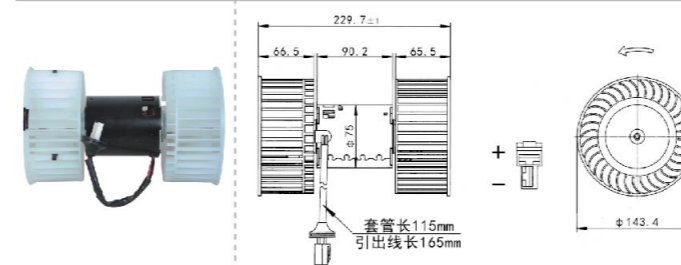

红岩杰狮  
GENLYON

VOLTAGE:24V  
CURRENT:≤12.5A  
TUM SPEED:≥3400RPM

BS-77060

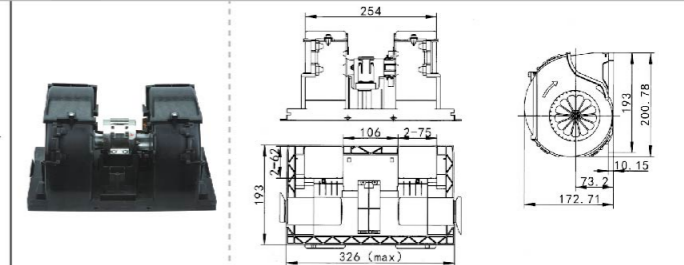

福田 GTL  
FOTON GTL

VOLTAGE:24V  
CURRENT:≤12.5A  
TUM SPEED:≥3300RPM

BS-77061

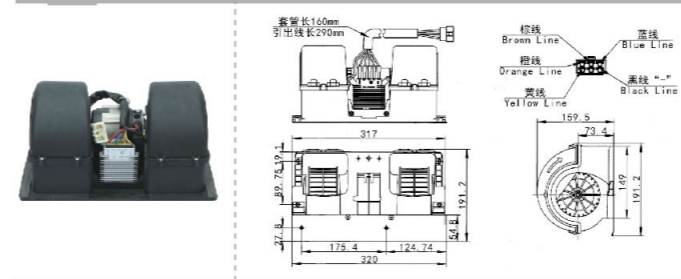

联合重卡  
C&C

VOLTAGE:24V  
CURRENT:≤11.8A  
TUM SPEED:≥3660RPM

BS-77065

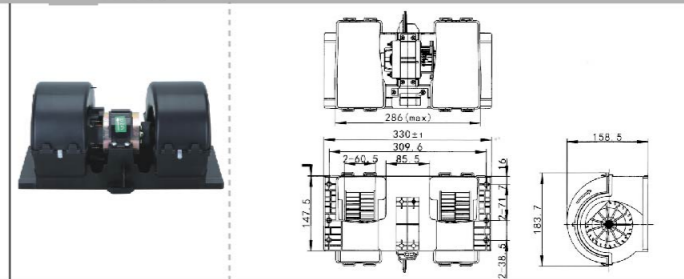

解放 JH06  
FAW JH06

VOLTAGE:24V  
CURRENT:≤  
TUM SPEED:≥

BS-66638



NISSAN C22  
日产

BS-66639



NISSAN UD PKC211  
24V  
日产

BS-66638



288-1556 RC.530.213  
Evaporator Box Fan Excavator Caterpillar  
Forestry Line 320CFM/ 320DFM/ 325CFM/  
330C/ 568FM - 24 Volts

BLOWER MOTOR

BLOWER MOTOR



BS-77020BBL

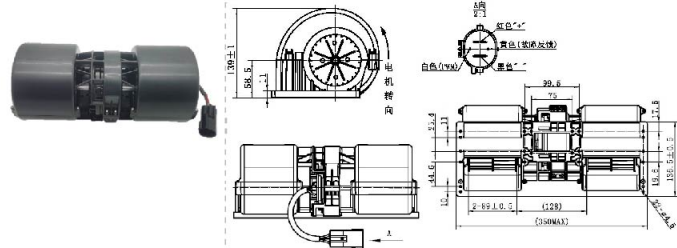

额定电压 Rated voltage: 电压范围 Voltage range:  
启动电压 Starting voltage: 额定电流 Rated current:  
转速范围 Speed range: 额定转速 Rated speed:  
电机功率 Motor power: 压差 Mpa:  
风量 Max air volume: 控制方式 Control system:

BS-77035BBL



| 风机性能表 (24V) |        |         |
|-------------|--------|---------|
| 占空比 (%)     | 电流 (A) | 转速 (R)  |
| 1-14停止      | /      | /       |
| 15启动        | 0.3    | 880±5%  |
| 90-98全速     | 14     | 3800±5% |
| 99停止        | /      | /       |

额定电压 Rated voltage: 电压范围 Voltage range:  
启动电压 Starting voltage: 额定电流 Rated current:  
转速范围 Speed range: 额定转速 Rated speed:  
电机功率 Motor power: 压差 Mpa:  
风量 Max air volume: 控制方式 Control system:

BS-77036BL



额定电压 Rated voltage: 电压范围 Voltage range:  
启动电压 Starting voltage: 额定电流 Rated current:  
转速范围 Speed range: 额定转速 Rated speed:  
电机功率 Motor power: 压差 Mpa:  
风量 Max air volume: 控制方式 Control system:

BS-77091B-DJ

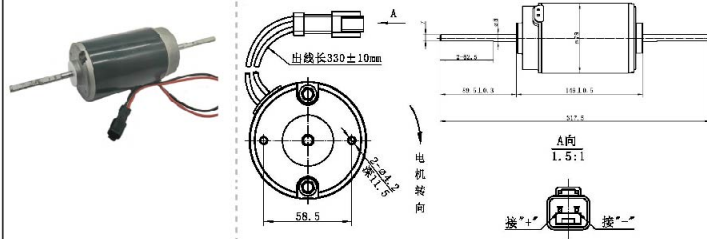

VOLTAGE:24V  
CURRENT:≤4A  
TUM SPEED:≥5600RPM

BS-77015A/BS-77015B

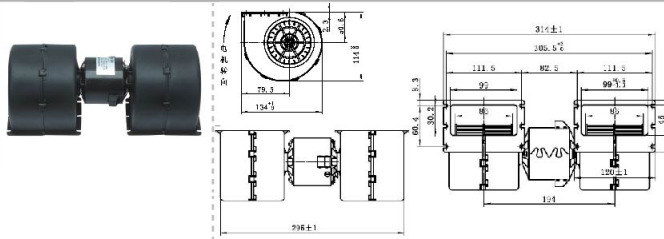

VOLTAGE:12V  
CURRENT:≤11.5A  
TUM SPEED:≥4100RPM

BS-77016AS/BS-77016BS/BS-77016AF/BS-77016BF

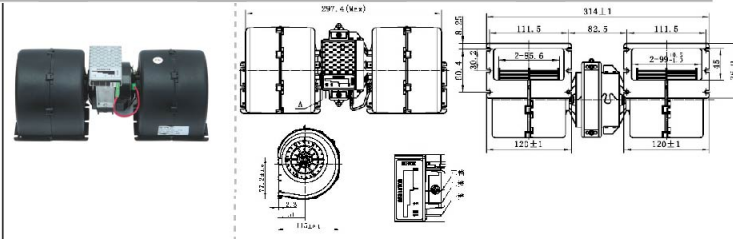

VOLTAGE:12V/24V  
CURRENT:≤  
TUM SPEED:≥

BS-77019A/BS-77019B

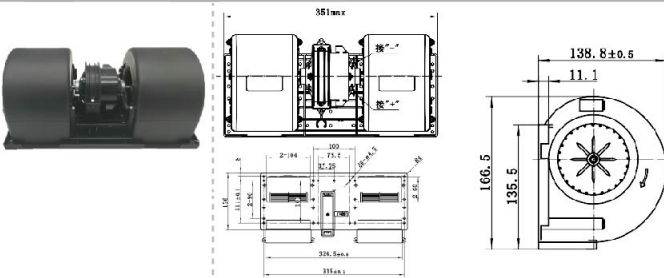

VOLTAGE:12/24V  
CURRENT:≤10A  
TUM SPEED:≥3500RPM

BS-77019AS/BS-77019BS/BS-77019AF/BS-77019BF

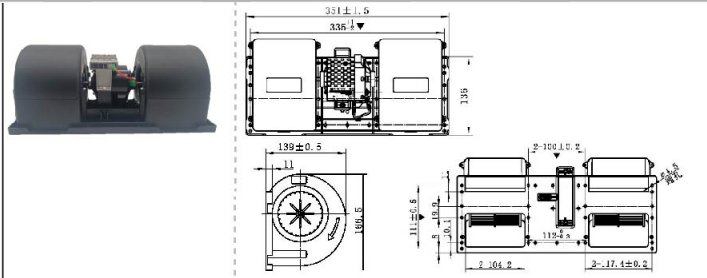

VOLTAGE:12V/24V  
CURRENT:≤  
TUM SPEED:≥



BS-77021A/BS-77021B

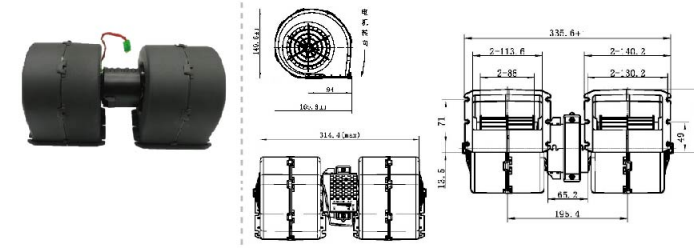

VOLTAGE:12/24V  
CURRENT:≤9A  
TUM SPEED:≥3600RPM

BS-77021AS/77021BS/77021AF/77021BF

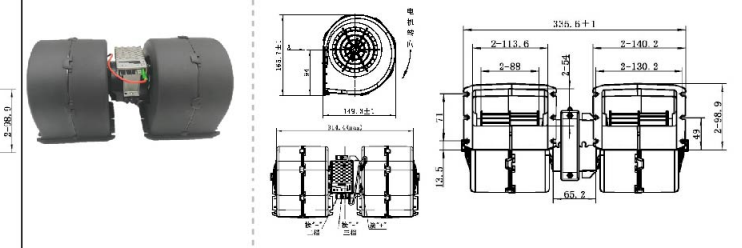

VOLTAGE:12/24V  
CURRENT:≤4.4/5.5/7.6A  
TUM SPEED:≥2550/3000/3400RPM

BS-77011DB

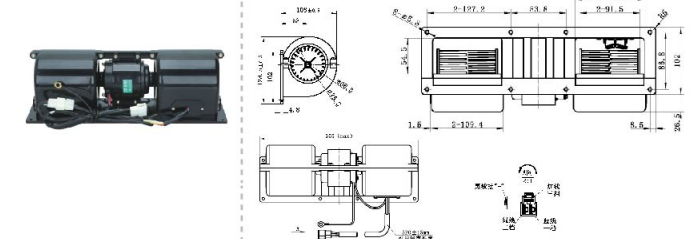

VOLTAGE:24V  
CURRENT:≤3.5/4.5/6.8A  
TUM SPEED:≥2700/3400/3900RPM

BS-77011WDZA/BS-77011WDZB

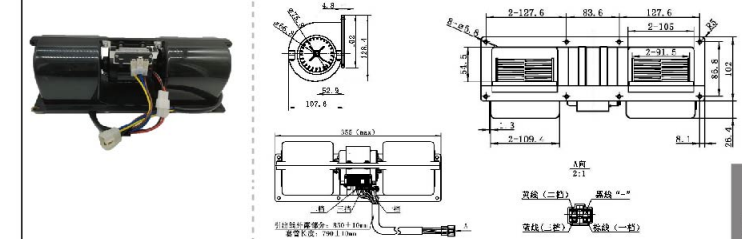

VOLTAGE:12/24V  
CURRENT:≤7.5/9.5/13.5A  
TUM SPEED:≥2550/3000/3650RPM

BS-77088A/BS-77088B

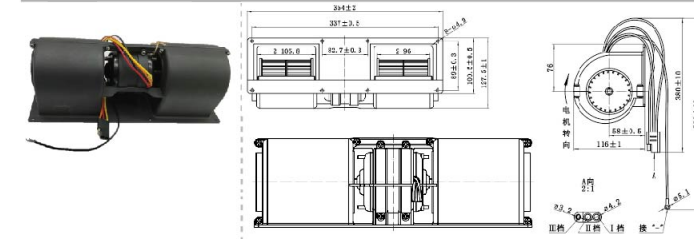

VOLTAGE:12/24V  
CURRENT:≤3.1/4.0/6.2A  
TUM SPEED:≥2400/2900/3600RPM

BS-77103



BS-77104



BS-77105





BS-77106

BS-77107



BS-77108

BS-77092B-DJ

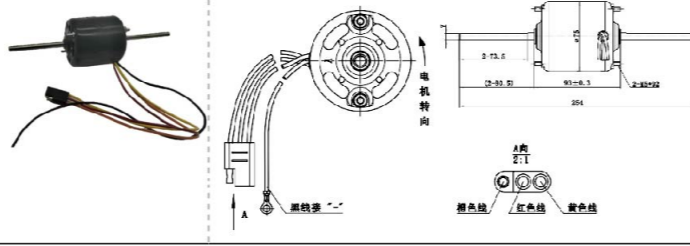

VOLTAGE:24V  
CURRENT:≤2.5A  
TUM SPEED:7000-10000RPM

BS-77029B

BS-77024A/BS-77024B

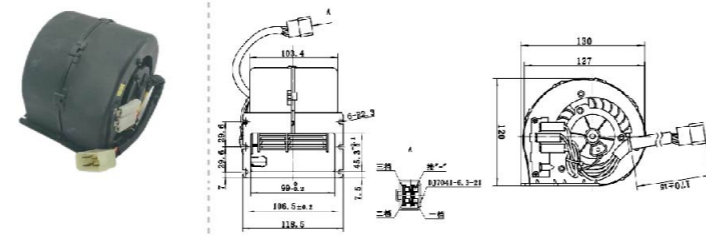
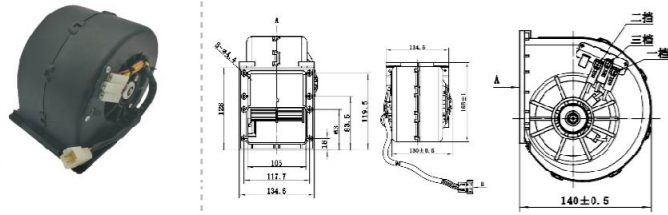

VOLTAGE:24V  
CURRENT:≤8A  
TUM SPEED:≥3800RPM

VOLTAGE:12V/24V  
CURRENT:≤2.1/2.6/3.8A  
TUM SPEED:≥2450/2900/3500RPM

BS-77023A/BS-77023B

BS-77030A

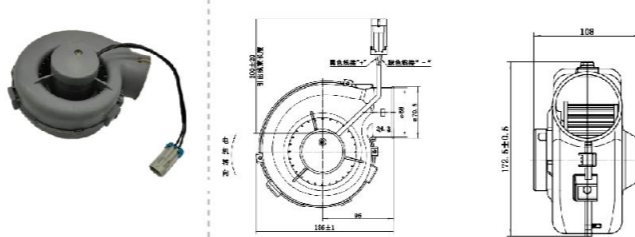
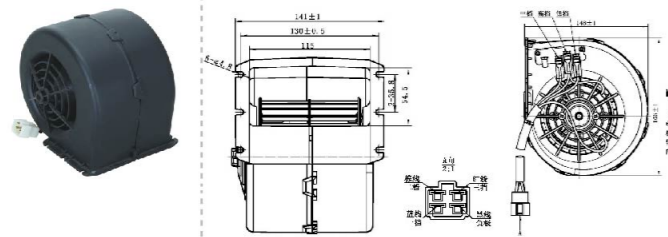

VOLTAGE:12V/24V  
CURRENT:≤5.3/6.5/8.2A  
TUM SPEED:≥2500/2800/3150RPM

VOLTAGE:12V  
CURRENT:≤7.5A  
TUM SPEED:≥3000RPM



SL-11324AX-1411

SL-11504BX-1211

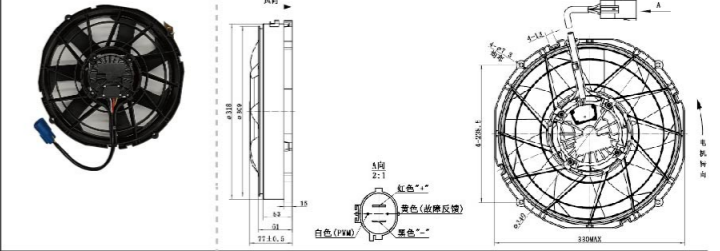
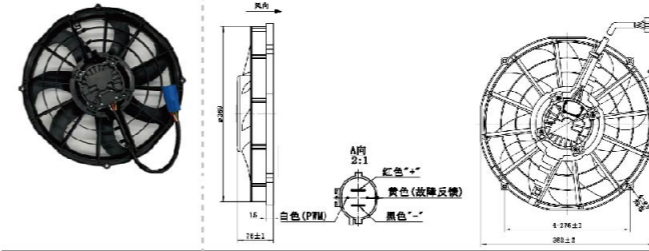

VOLTAGE:  
CURRENT:  
TUM SPEED:

VOLTAGE:24V  
CURRENT:≤32A  
TUM SPEED:≥4700RPM

SL-11513BX-1221

SL-11315AX-1111

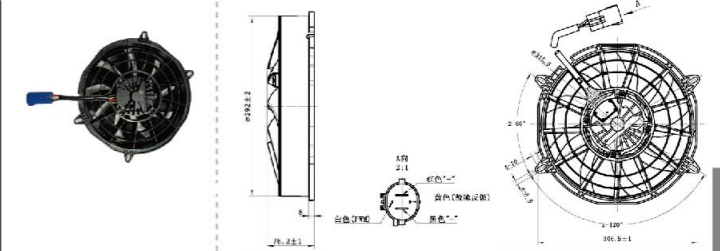
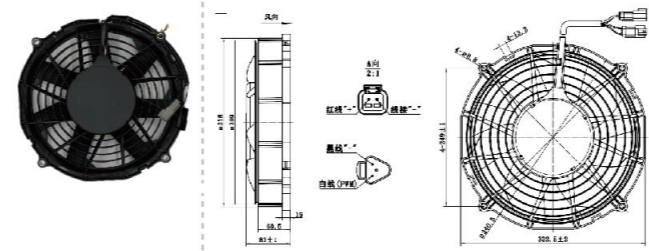

VOLTAGE:24V  
CURRENT:≤20.5A  
TUM SPEED:≥4100RPM

VOLTAGE:12V  
CURRENT:≤18.5A  
TUM SPEED:≥3800RPM

SL-11330BX-1011

SL-11335AX-0911

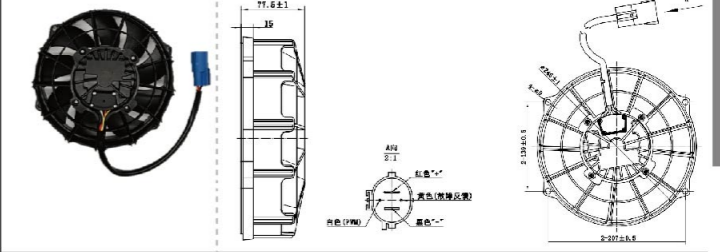
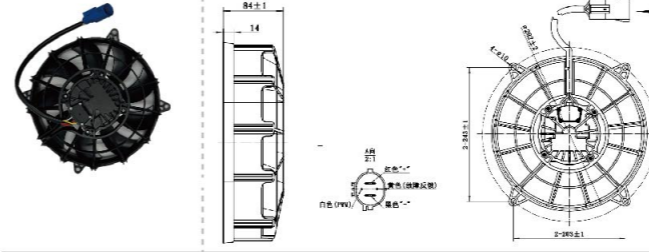

VOLTAGE:  
CURRENT:  
TUM SPEED:

VOLTAGE:  
CURRENT:  
TUM SPEED:

SL-96160A-11S01

SL-96160A-12S01

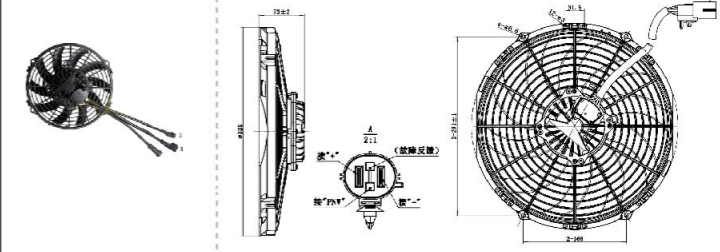
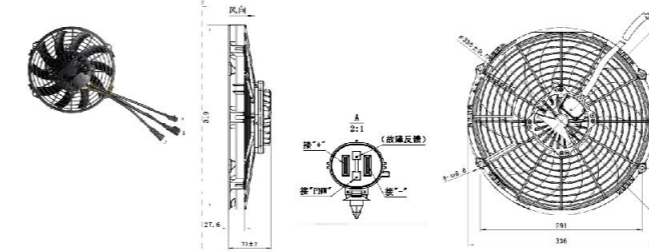

VOLTAGE:  
CURRENT:  
TUM SPEED:

VOLTAGE:  
CURRENT:  
TUM SPEED:



...Universal Fan

BS-809YWX

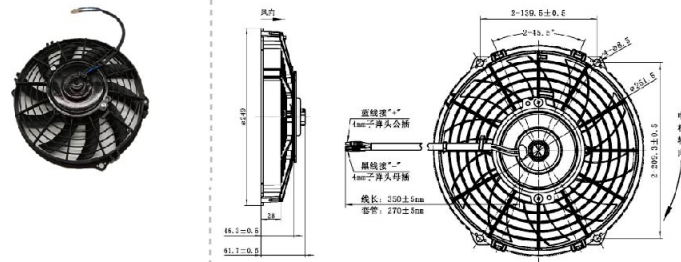

VOLTAGE:12V  
CURRENT:≤5.5A  
TUM SPEED:≥2830RPM

BS-810FWXA

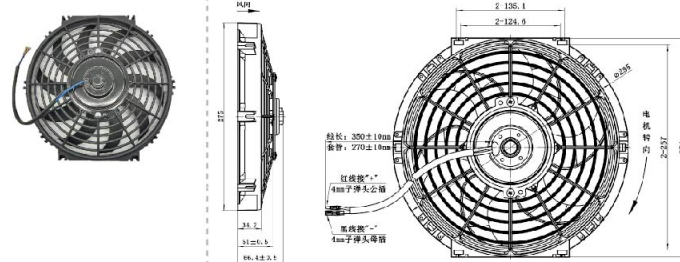

VOLTAGE:  
CURRENT:  
TUM SPEED:

BS-810YWX

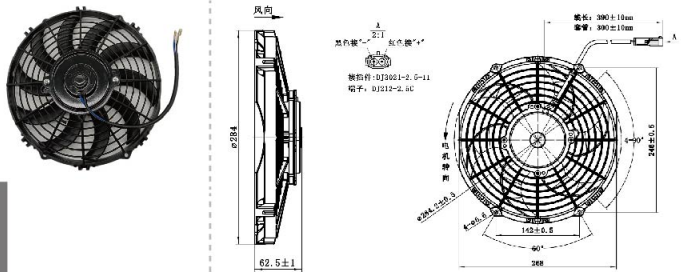

VOLTAGE:  
CURRENT:  
TUM SPEED:

BS-810FZXA

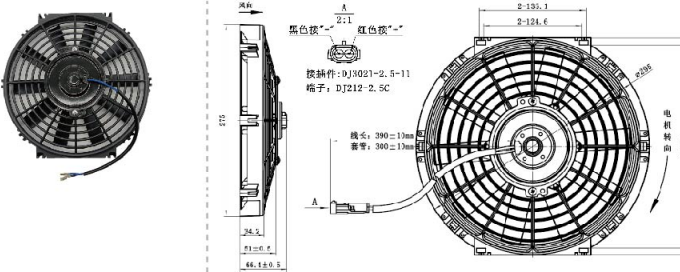

VOLTAGE:  
CURRENT:  
TUM SPEED:

BS-811FZXA

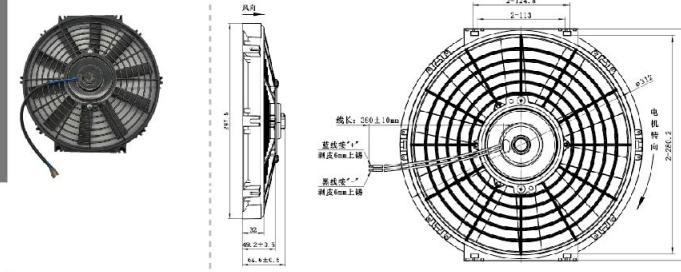

VOLTAGE:12V  
CURRENT:7.5A  
TUM SPEED:≥2160RPM

BS-811FWXA

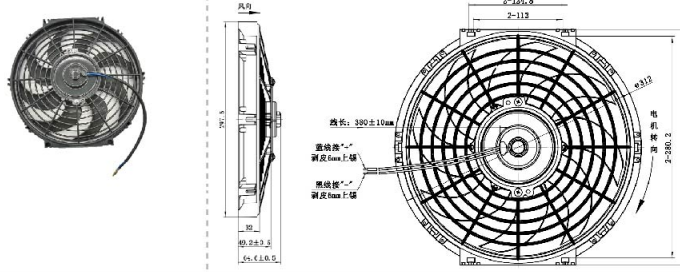

VOLTAGE:12V  
CURRENT:7.5A  
TUM SPEED:≥2160RPM

BS-812YWX

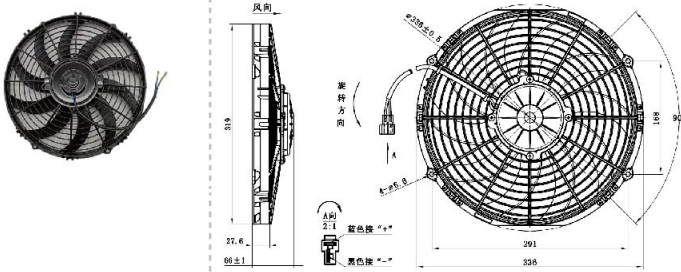

VOLTAGE:24V  
CURRENT:7A  
TUM SPEED:≥2600RPM

BS-814FZXA

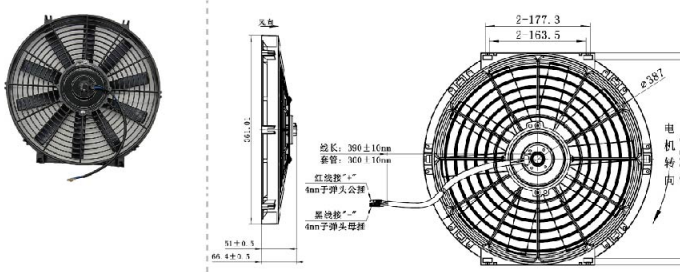

VOLTAGE:  
CURRENT:  
TUM SPEED:



...Universal Fan

SL-18A5-65S02

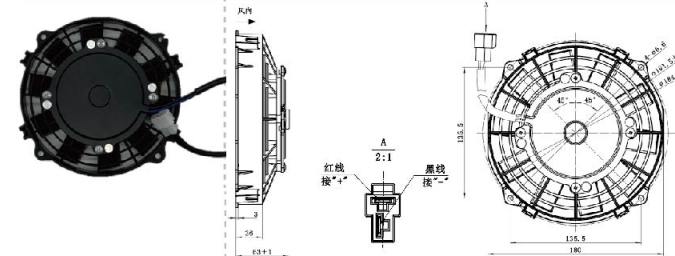

VOLTAGE:12V  
CURRENT:≤5A  
TUM SPEED:≥3400RPM

SL-18A7-07S02

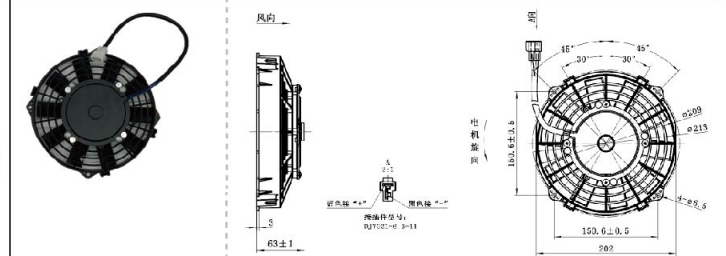

VOLTAGE:24V  
CURRENT:≤4A  
TUM SPEED:≥3400RPM

SL-12A5-09S01

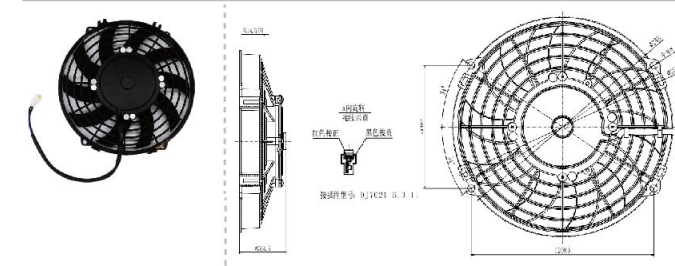

VOLTAGE:12V  
CURRENT:≤10A  
TUM SPEED:≥3100RPM

SL-12A5-10S01

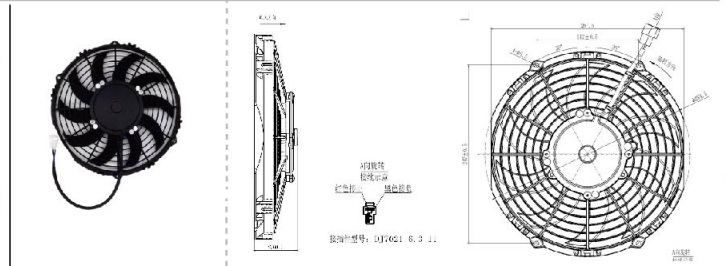

VOLTAGE:12V  
CURRENT:≤10A  
TUM SPEED:≥3100RPM

SL-32B5-11S01

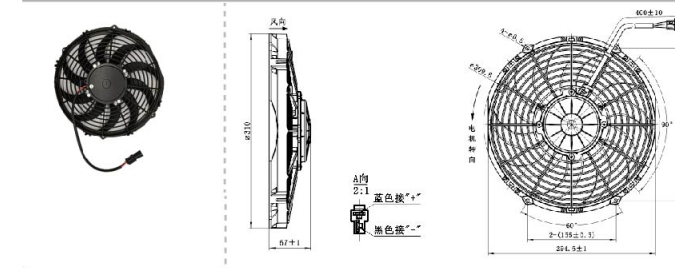

VOLTAGE:24V  
CURRENT:≤8A  
TUM SPEED:≥2800RPM

SL-32B5-12S01

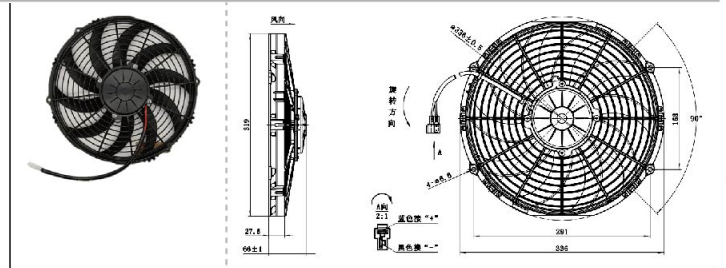

VOLTAGE:24V  
CURRENT:≤7A  
TUM SPEED:≥2600RPM

SL-H36B7-14B02

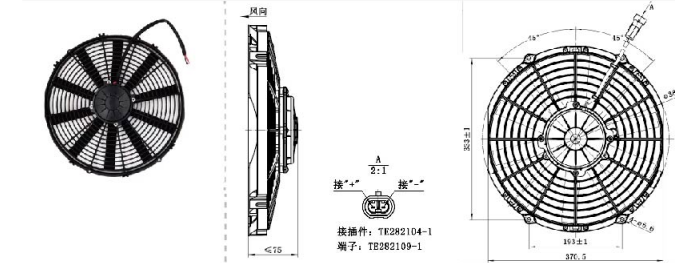

VOLTAGE:24V  
CURRENT:≤8A  
TUM SPEED:≥2400RPM

SL-T36B5-16YZXH

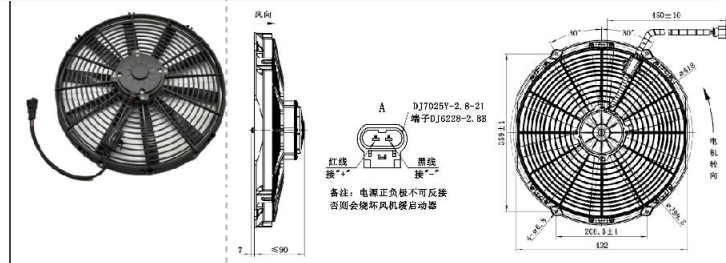

VOLTAGE:24V  
CURRENT:≤7A  
TUM SPEED:≥2450RPM

BLOWER MOTOR

BLOWER MOTOR

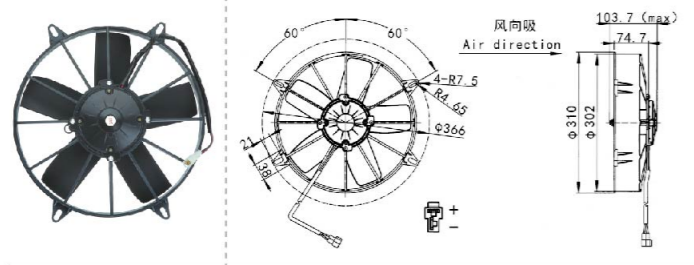
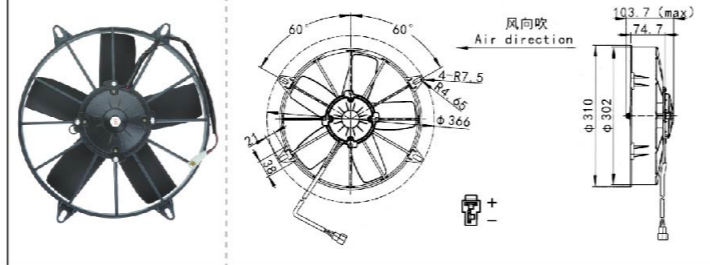
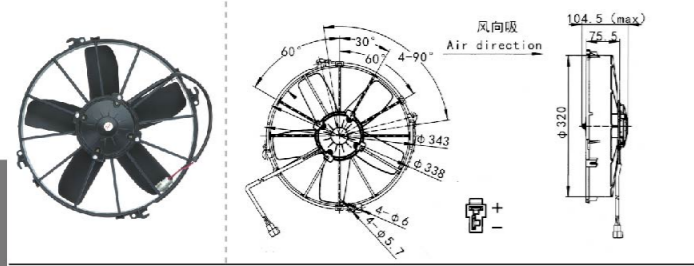
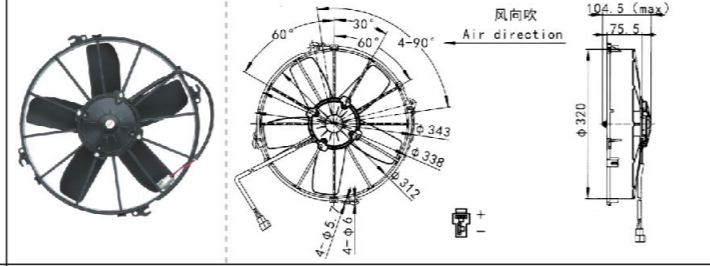
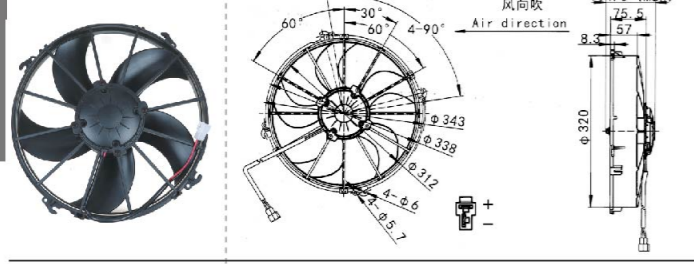
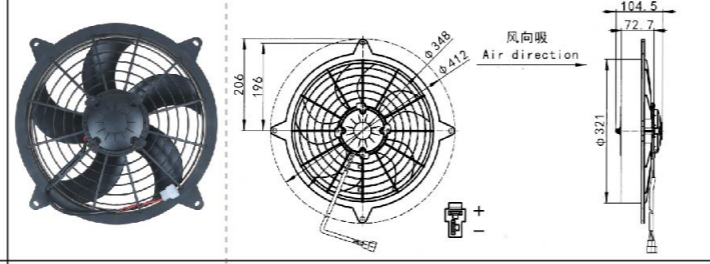
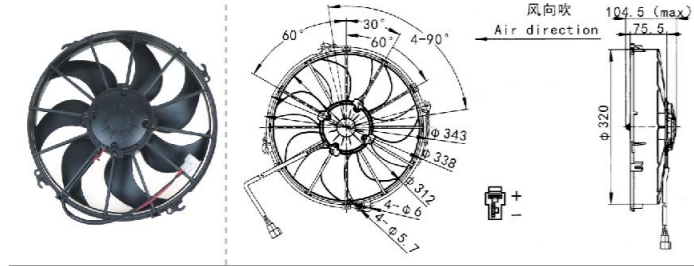
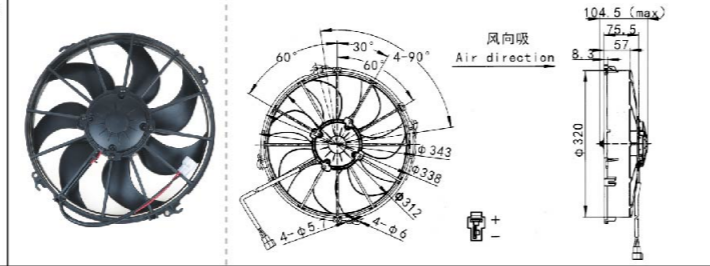

|   |   |
|---|---|
| <p>BS-88001</p>     | <p>BS-88002</p>     |
| <p>圆框 外径305<br/>直叶 5叶 吸风 SUCTION<br/>VOLTAGE:24V<br/>CURRENT:≤8A<br/>TUM SPEED:≥2850RPM</p>         | <p>圆框 外径305<br/>直叶 5叶 吹风 BLOWING<br/>VOLTAGE:24V<br/>CURRENT:≤8A<br/>TUM SPEED:≥2850RPM</p>           |
| <p>BS-88003</p>     | <p>BS-88004</p>     |
| <p>圆框 外径330<br/>直叶 5叶 吸风 SUCTION<br/>VOLTAGE:24V<br/>CURRENT:≤8.8A<br/>TUM SPEED:≥2800RPM</p>       | <p>圆框 外径330<br/>直叶 5叶 吹风 BLOWING<br/>VOLTAGE:24V<br/>CURRENT:≤8.8A<br/>TUM SPEED:≥2800RPM</p>         |
| <p>BS-88005</p>   | <p>BS-88000</p>   |
| <p>圆框 外径330<br/>弯叶 5叶 吹风 BLOWING<br/>VOLTAGE:24V<br/>CURRENT:≤7.5A<br/>TUM SPEED:≥2800RPM</p>       | <p>方框 5叶 吸风 SUCTION<br/>VOLTAGE:24V<br/>CURRENT:≤7.5A<br/>TUM SPEED:≥2800RPM</p>                      |
| <p>BS-88007C</p>  | <p>BS-88007X</p>  |
| <p>大巴 7叶 弯<br/>吹风 BLOWING<br/>VOLTAGE:24V<br/>CURRENT:≤7.5A<br/>TUM SPEED:≥2800RPM</p>              | <p>大巴 7叶 弯<br/>吸风 SUCTION<br/>VOLTAGE:24V<br/>CURRENT:≤7.5A<br/>TUM SPEED:≥2800RPM</p>                |

BLOWER MOTOR

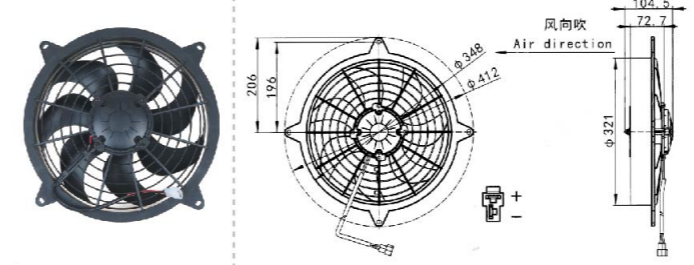
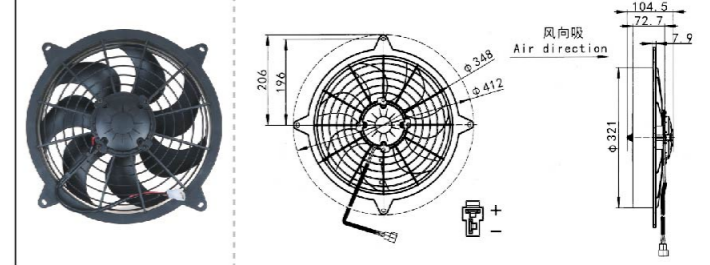
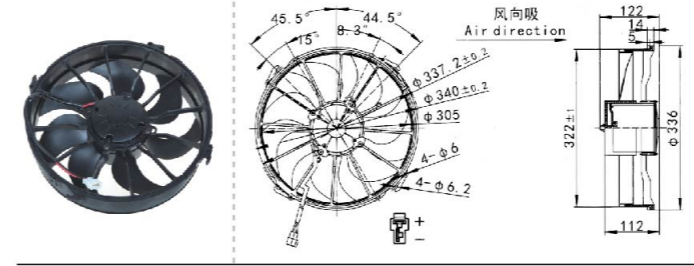
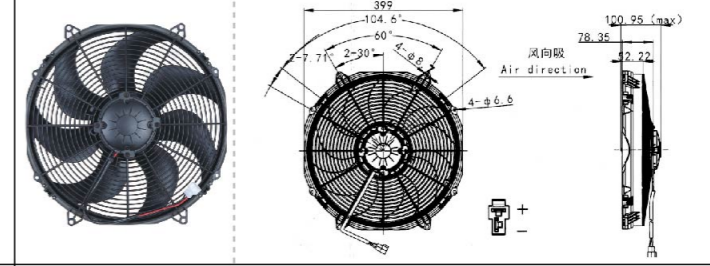
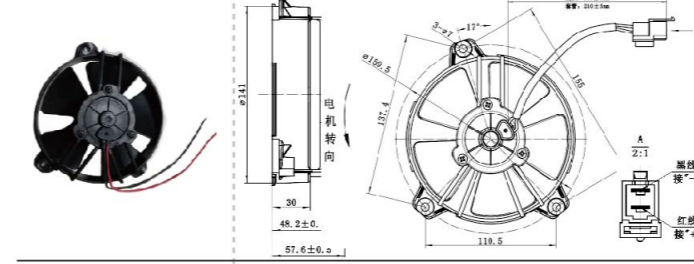
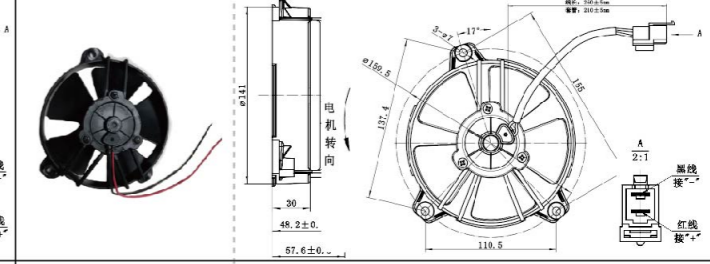
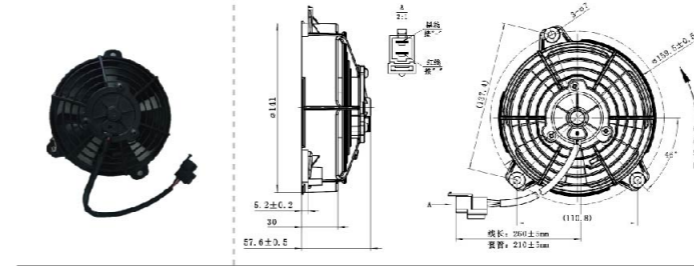

|  |  |
|--|--|
| <p>BS-88008C</p>    | <p>BS-88008X</p>    |
| <p>方框 7叶<br/>吹风 BLOWING<br/>VOLTAGE:24V<br/>CURRENT:≤7.5A<br/>TUM SPEED:≥2800RPM</p>                   | <p>方框 7叶<br/>吸风 SUCTION<br/>VOLTAGE:24V<br/>CURRENT:≤7.5A<br/>TUM SPEED:≥2800RPM</p>                   |
| <p>BS-88009</p>     | <p>BS-88017</p>     |
| <p>BUS 大功率<br/>VOLTAGE:24V<br/>CURRENT:≤14A<br/>TUM SPEED:≥2800RPM</p>                                 | <p>16寸 通用电子扇<br/>VOLTAGE:A:12V B:24V<br/>CURRENT:≤12A<br/>TUM SPEED:≥2600RPM</p>                       |
| <p>BS-88021A</p>  | <p>BS-88022A</p>  |
| <p>VOLTAGE:<br/>CURRENT:<br/>TUM SPEED:</p>  | <p>VOLTAGE:<br/>CURRENT:<br/>TUM SPEED:</p>  |
| <p>BS-88053A</p>  |  |
| <p>VOLTAGE:12V<br/>CURRENT:≤3.5A<br/>TUM SPEED:≥5600RPM</p>  |  |

BLOWER MOTOR



BS-88101BL



A0999060612

Mercedes-Benz  
S400/S550/S600/S63/S65

BS-88102BL



A0999063902

Mercedes-Benz E级

BS-88103BL



0999061100  
0999061800

Mercedes-Benz  
C180L/C200L/C260L  
C300L/E200L/GLC200

BS-88104BL



1645000593  
A1645000493  
A1645000193

Mercedes-Benz  
ML350/ML300/ML350  
ML500/R320/R350/R500

BS-88105BL



A0999062400  
A0999060700

Mercedes-Benz  
GLE400/GLE350  
GLE320/GLE450  
GLE300

BS-88106BL



002009323

Mercedes-Benz  
精灵 FOR TWO  
Cabrio (451)

BS-88107BL



2035001693  
2035001493  
2035400788

Mercedes-Benz  
C230/C280/C350  
C240/C320/C240

BS-88108BL



2215000993  
A2215001093  
A2219066500  
A2215001193  
A2115000493

Mercedes-Benz  
S320/S500/S350/S450



BS-88109BL



2045000293  
A2049066802  
A2045000393  
A2045000493  
A2049061403

Mercedes-Benz  
C180K/C200  
C180/C200K  
C230/C280  
C260/C300/E200  
E260/E300

BS-88150BL



17418642161  
17417618787  
17418617103  
17418619143

BMW 520Li/528i/528iX  
520i/528i/528iX

BS-88151BL



17427560877

BMW X3 2011-2017

BS-88152BL



17427547305  
17427562080  
17427522055

BMW 130i/125i/128i/125i/128i  
320i/323i/325i/325xi/328i/328xi  
330i/330xi/323i/325i/328i/330i  
X1 25iX/X1 28iX

BS-88153BL



17428509740  
17417589031  
17427804620

BMW  
528i/523i/530i/650i

BS-88154BL



17427634467  
17427634466

BMW:  
X5(F15)35i/28i  
X6(F16)35i/28

BS-88155BL



17427523259  
17117590699  
17427563259

BMW  
116i 1.6/130i/116i/125i/128i  
316i/318i/320i/323i/325i/325xi  
328i/328xi/330i/330xi/X1 18i  
Z4 23i/Z4 30i

BS-88156BL



17427601176

BMW xDrive28i(进口)



... BMW

BS-88157BL



17427540681  
17417545809

BMW  
523i/525i/530i/523i  
525i/530i/630i/630i

BS-88158BL



17428641963  
17427640509  
17428621191  
17427600558

BMW 116i/118d/118i/120d/125d/125i/116i/118i  
125d/125i/225D/316d/316i/318d/318dX/320d  
320d ed/320dX/320i/320i ed/320iX/325d/328i/316d  
316i/318d/318dX/320d/320d ed/320dX/320i/320iX/328i  
328iX/318d/320d/320dX/320i/325d/328i/320Li/420d  
420dX/420i/420iX/428i/428iX/420d/420dX

BS-88159BL



64546921381  
64546919051  
64506908124  
64546921940  
6454380573

BMW  
X5 3.0i/X5 4.4i/X5 4.4i  
X5 4.6is/X5 4.8is

BS-88160BL



17428618239  
17427598739  
17427616102

BMW  
X6 3.5iX/X6 40iX  
X5 35iX/X5 40iX

BS-88161BL



2045000193

BS-88162BL



17417589028

BMW 7系

BS-88163BL



17427543282  
17427514181

BMW 520i/520Li/523Li/523i  
525Li/525i/525xi/528i/530Li  
530i/530Xi/523i/525i/525xi  
530i/530Xi/545i/645Ci/630i  
645Ci/630i/730i/740i/750i  
730Li/740Li/750Li

BS-88164BL



17113452509  
17113414008  
17113401056  
17113415242  
17113405099

BMW X3(30i/25i/18d)

BLOWER MOTOR



... BMW

BS-88165BL



17428641964

BMW  
320i/330i/420i xdiver

BS-88166BL



64546921379

BMW  
760i/60Li

BS-88167BL



17113442089  
17113415181  
17113400022

BMW  
X3/06年(30i/25i)

BS-89312



93358515

Chevrolet S10/ Blazer c  
Ar Condicionado 03  
1995> - 12 Volts

BS-89311



Volkswagen Golf1.6/1.8/2.0 1999>  
Audi A3 - 12 Volts

BS-88201BL

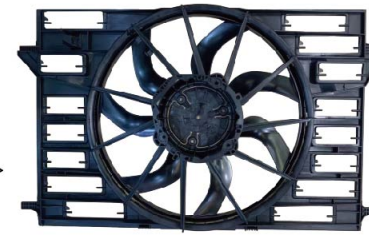

8w0959455

BS-89313



1TD 959 455

大众速腾/迈腾/途观  
散热器风扇电子扇主扇

BS-89314











1TD 959 455 F

大众速腾/迈腾/途观  
散热器风扇电子扇副扇

BLOWER MOTOR











Special electronic fan

|   |   |
|---|---|
| SL-89301  | SL-89302  |
|    |       |
| Eletroventilador do Corsa<br>>99 / S10 2.8 00> GMB  | Eletroventilador Chevrolet<br>Onix /Cobalt / Spin /<br>Prisma 2011>2016 1.0 / 1.4 / 1.8 |
| SL-89303  | SL-89305  |
|    |       |
| 20777078<br>VOLVO VM 210 220 240 260<br>270 310 330<br>COD. OEM-20777078  | Mercedes Benz<br>Volkswagen - 24 Volts  |
| SL-89306  | SL-89307  |
|    |      |
| Peugeot 306/ 405/ Partner/ Berlingo -<br>Diametro 315mm - 12 Volts 165 Watts  | RENAULT MASTER  |
| SL-89308  | SL-89309  |
|    |     |
| 550.090<br>Eletroventilador do Radiador<br>Volkswagen Polo/ Gol G5/<br>Saveiro G5/ Voyage/<br>Fox 3 Pinos Todos 2007> Importado | 20835928<br>Volkswagen/ Volvo c<br>Ar Condicionado - 24 Volts                           |

BLOWER MOTOR



Only Motor

|  |   |
|--|---|
| BS-51101   | BS-51102  |
|                         |    |
| 168000-1070<br>168000-1070,<br>16363-0D120,<br>168000-8470,<br>16363-0T030,<br>168000-8450,<br>16363-0V410 | TOYOTA ALTIS 08-10  |
| BS-51103   | BS-51104  |
|                         |    |
| S CCW 12V CAMRY 06,VIOS 07   | ACCORD 08-,CRV2012/CAMRY 2011   |
| BS-51105   | BS-51106  |
|                       |  |
| ALTIS VIOS   | TOYOTA VIOS'13(ท่าเหี่ยวแล้ว)   |
| BS-51107   | BS-51109  |
|                       |  |
| 062500-6721<br>88550-28060   | 16363-74370<br>263500-5311  |
| 丰田Revo (后左)  | Toyota Camry:ACV30/30L/<br>31/35;SXV20/23<br>Toyota Mark II                           |

BLOWER MOTOR



Only Motor

|                            |                                 |   |  |
|----------------------------|---------------------------------|---|--|
| BS-51110                   |                                 | BS-51111  |  |
|                            |                                 |   |  |
| 16363-02120<br>263500-5251 | Toyota Camry/Hybrid/VIOS/Soluna | 16363-10010   | 雷克萨斯 ES330   |
| BS-51112                   |                                 | BS-51113/BS-51113F                                      |  |
|                            |                                 |   |  |
|                            | TOYOTA HINO 24V 2013กอน         | 16363-20390<br>16363-75030<br>168000-5470<br>1636320390 | TOYOTA COMMUTOR  |
| BS-51115                   |                                 | BS-51116  |  |
|                            |                                 |   |  |
| 21487-4Z320                | 丰田凯美瑞                           | 16363-30041   | 1. 丰田海狮04至12年款<br>2. 海狮搭载1KD、2KD、5LE发动机<br>3. 丰田hiace V BOX2005-2012 (部分车型)<br>4. 丰田hiace IV BOX1995-2006 (部分车型) |
| BS-51117                   |                                 | BS-51201  |  |
|                            |                                 |   |  |
| 16363-0A200<br>168000-9040 | 雷克萨斯 ES300<br>雷克萨斯 ES300        | 168000-8801 / 8800<br>168000-8060<br>AE168000-1270      | HONDA CIVIC'13 /CCITY'14 / HRV   |

BLOWER MOTOR



Only Motor

|          |  |          |                               |
|----------|--|----------|-------------------------------|
| BS-51202 |  | BS-51203 |                               |
|          |  |          |                               |
|          | HONDA CV06-11<br>ACCORD2.0-2.4 03-07 CRV |          | S CCW 12V CAMRY06             |
| BS-51204 |  | BS-51301 |                               |
|          |  |          |                               |
|          | AVANZA2012,HONDA CV、ACCORD               |          | ACCORD 08-,CRV2012/CAMRY 2011 |
| BS-51302 |  | BS-51303 |                               |
|          |  |          |                               |
|          | TIIDA                                    |          | NISSAN TIIDA เทียบรถยนต์ 06   |
| BS-51304 |  | BS-51305 |                               |
|          |  |          |                               |
|          | NISSAN JUKE(L)CCW SYLPHY                 |          | MARCH/ALMERA                  |

BLOWER MOTOR



Only Motor

|             |                                      |          |                               |
|-------------|--------------------------------------|----------|-------------------------------|
| BS-51701    |                                      | BS-51702 |                               |
|             |                                      |          |                               |
| 168000-7030 | MITSU MIRAGE<br>ATTAGE CW 12V S      |          | MITSUBISHI LANCER EX          |
| BS-51703    |                                      | BS-51801 |                               |
|             |                                      |          |                               |
|             | MITSU STRADA / TRITON<br>PAJEROSPORT |          | SUZUKI CARRY OLD(M)           |
| BS-51802    |                                      | BS-52101 |                               |
|             |                                      |          |                               |
|             | SUZUKI CARRY NEW(L)                  |          | HYUANDAI HI / STAREX / 4H1000 |
| BS-54102    |                                      | BS-54401 |                               |
|             |                                      |          |                               |
|             | FORD FIESTA                          |          | CHE CAPTIVA                   |

BLOWER MOTOR



Only Motor

|                            |                 |          |                |
|----------------------------|-----------------|----------|----------------|
| BS-54402                   |                 | BS-54403 |                |
|                            |                 |          |                |
|                            | CHE AVEO        |          | AVEO 08 UP     |
| BS-59101                   |                 | BS-59901 |                |
|                            |                 |          |                |
|                            | TATA(R&L)       |          |                |
| BS-59903                   |                 | BS-59904 |                |
|                            |                 |          |                |
| 16363-0A200<br>168000-9040 | Toyota New Vios |          | FE12-2108-YH   |
| BS-59905                   |                 | BS-59906 |                |
|                            |                 |          |                |
|                            | 25386-B9130     |          | AHG27B2-K2361B |

BLOWER MOTOR

